

Rochester Institute of Technology

**RIT Digital Institutional Repository**

---

Theses

---

4-2019

## **Improving Developer Profiling and Ranking to Enhance Bug Report Assignment**

Andrew DiStasi  
add5980@rit.edu

Follow this and additional works at: <https://repository.rit.edu/theses>

---

### **Recommended Citation**

DiStasi, Andrew, "Improving Developer Profiling and Ranking to Enhance Bug Report Assignment" (2019). Thesis. Rochester Institute of Technology. Accessed from

This Thesis is brought to you for free and open access by the RIT Libraries. For more information, please contact [repository@rit.edu](mailto:repository@rit.edu).

# **Improving Developer Profiling and Ranking to Enhance Bug Report Assignment**

by

**Andrew DiStasi**

A Thesis Submitted in Partial Fulfillment of the  
Requirements for the Degree of  
Master of Science in Software Engineering

Supervised by  
Dr. Mohamed Wiem Mkaouer

Department of Software Engineering  
B. Thomas Golisano College of Computing and Information Sciences  
Rochester Institute of Technology  
Rochester, New York

April 2019

The thesis “Improving Developer Profiling and Ranking to Enhance Bug Report Assignment” by Andrew DiStasi has been examined and approved by the following Examination Committee:

---

Dr. Mohamed Wiem Mkaouer  
Assistant Professor, RIT  
Thesis Committee Chair

---

Dr. Christian Newman  
Assistant Professor, RIT

---

Dr. Pradeep Murukannaiah  
Assistant Professor, RIT

---

Dr. Xin Ye  
Assistant Professor, CSUSM

---

Dr. J. Scott Hawker  
Associate Professor  
Graduate Program Director, RIT

# Dedication

To my family who supported me, my teachers who instilled an early love of learning in me, and my friends who walked with me.

# Acknowledgments

There are many people who have played a role in helping and supporting me through both my entire RIT Career and my Masters studies. First, I'd like to thank my advisor, Dr. Mohamed Wiem Mkaouer for introducing me to the topic of bug triage, as well as all his encouragement, advice, and guidance throughout the work on my thesis. Additionally, I'd like to thank all of the RIT faculty and staff, both in the Software Engineering and Information Sciences and Technologies departments, who have provided support during my time at RIT.

Next, I'd like to thank my father, Dr. Vincent DiStasi, for sparking my interest in technology, for his never-ending support, and for making the completion of this research possible with his generous gift of (many) virtual servers to run my code in a timely manner. I'd also like to thank my mother, Kathleen DiStasi, and the rest of my family for their unwavering love and support - this work would not have been possible without them. Finally, I'd like to thank the RIT Honors Program for being my "college family" and such a critical part of what has made my 7 years at RIT so memorable. In particular, I am incredibly grateful to Kerrie Bondi and Rebecca Jasen for their endless support and guidance. I am grateful to everyone that has supported me during this journey and express my apologies for not being able to mention them each by name.

# **Abstract**

## **Improving Developer Profiling and Ranking to Enhance Bug Report Assignment**

**Andrew DiStasi**

**Supervising Professor: Dr. Mohamed Wiem Mkaouer**

Bug assignment plays a critical role in the bug fixing process. However, bug assignment can be a burden for projects receiving a large number of bug reports. If a bug is assigned to a developer who lacks sufficient expertise to appropriately address it, the software project can be adversely impacted in terms of quality, developer hours, and aggregate cost. An automated strategy that provides a list of developers ranked by suitability based on their development history and the development history of the project can help teams more quickly and more accurately identify the appropriate developer for a bug report, potentially resulting in an increase in productivity. To automate the process of assigning bug reports to the appropriate developer, several studies have employed an approach that combines natural language processing and information retrieval techniques to extract two categories of features: one targeting developers who have fixed similar bugs before and one targeting developers who have worked on source files similar to the description of the bug. As developers document their changes through their commit messages it represents another rich resource for profiling their expertise, as the language used in commit messages typically more closely matches the language used in bug reports. In this study, we have replicated the approach presented in [32] that applies a learning-to-rank technique to rank appropriate

developers for each bug report. Additionally, we have extended the study by proposing an additional set of features to better profile a developer through their commit logs and through the API project descriptions referenced in their code changes. Furthermore, we explore the appropriateness of a joint recommendation approach employing a learning-to-rank technique and an ordinal regression technique. To evaluate our model, we have considered more than 10,000 bug reports with their appropriate assignees. The experimental results demonstrate the efficiency of our model in comparison with the state-of-the-art methods in recommending developers for open bug reports.

# Contents

<b>Dedication</b> . . . . .	<b>iii</b>
<b>Acknowledgments</b> . . . . .	<b>iv</b>
<b>Abstract</b> . . . . .	<b>v</b>
<b>1 Introduction</b> . . . . .	<b>1</b>
<b>2 Background</b> . . . . .	<b>4</b>
2.1 Bug Lifecycle Overview . . . . .	4
2.2 Version Control Overview . . . . .	7
2.3 Project API Documentation Overview . . . . .	8
<b>3 Related Work</b> . . . . .	<b>9</b>
<b>4 Problem Statement</b> . . . . .	<b>13</b>
<b>5 Feature Engineering</b> . . . . .	<b>15</b>
5.1 Feature Use Overview . . . . .	15
5.2 Text Preprocessing . . . . .	16
5.3 Text Comparison Algorithm . . . . .	17
5.4 Feature Extraction . . . . .	18
5.4.1 Activity-Based Features . . . . .	19
5.4.2 Location-Based Features . . . . .	23
5.4.3 Developer Profile-Based Features . . . . .	25
5.5 Feature Scaling . . . . .	27
<b>6 Feature Combination</b> . . . . .	<b>28</b>
6.1 Naive Aggregation . . . . .	28
6.2 Learning to Rank . . . . .	29
6.3 Ordinal Regression . . . . .	29



6.4	Joint Recommendation . . . . .	30
<b>7</b>	<b>Experimental Methodology . . . . .</b>	<b>31</b>
7.1	Research Questions . . . . .	31
7.2	Data Collection and Filtration . . . . .	32
7.3	Projects Used . . . . .	33
7.4	Database Structure . . . . .	34
7.5	Linking Heuristic . . . . .	35
7.6	Experiment Setup and Evaluation Metrics . . . . .	36
<b>8</b>	<b>Experimental Results and Evaluation . . . . .</b>	<b>38</b>
8.1	Feature Set Accuracy Evaluation . . . . .	38
8.2	Feature Combination Accuracy Evaluation . . . . .	42
8.3	Joint-Recommendation Accuracy Evaluation . . . . .	46
8.4	Evaluation of Feature Importance . . . . .	47
8.5	Training Size Impact Evaluation . . . . .	48
<b>9</b>	<b>Threats to Validity and Future Work . . . . .</b>	<b>50</b>
9.1	Threats to Validity . . . . .	50
9.2	Future Work . . . . .	51
<b>10</b>	<b>Conclusion . . . . .</b>	<b>54</b>
	<b>Bibliography . . . . .</b>	<b>55</b>
<b>A</b>	<b>RQ1 Full Comparisons . . . . .</b>	<b>62</b>
<b>B</b>	<b>RQ4: All Feature Weights . . . . .</b>	<b>66</b>

# List of Tables

3.1	Feature Types Considered in Related Works . . . . .	9
5.1	Features used in the Ranking Model . . . . .	18
7.1	Subject Projects Considered for Evaluation. . . . .	33
8.1	Top-5 Weighted Features for each project . . . . .	48
B.1	Weights of all features used in the Ranking Model . . . . .	66

# List of Figures

2.1	Bug Report #384108 from Eclipse Platform UI as reported in BugZilla. . . . .	5
2.2	Lifecycle of a Bug . . . . .	6
5.1	Approach Overview. . . . .	15
5.2	Bug Report #384056 from Eclipse UI. . . . .	26
8.1	Accuracy Comparison Between Features for AspectJ . . . . .	40
8.2	Accuracy Comparison Between Features for BIRT . . . . .	40
8.3	Accuracy Comparison Between Features for Eclipse Platform UI . . . . .	41
8.4	Accuracy Comparison Between Features for JDT . . . . .	41
8.5	Accuracy Comparison Between Features for SWT . . . . .	42
8.6	Accuracy Comparison Between Features for Tomcat . . . . .	42
8.7	Accuracy Comparison Across Feature Combination for AspectJ . . . . .	44
8.8	Accuracy Comparison Across Feature Combination for BIRT . . . . .	44
8.9	Accuracy Comparison Across Feature Combination for Eclipse . . . . .	45
8.10	Accuracy Comparison Across Feature Combination for JDT . . . . .	45
8.11	Accuracy Comparison Across Feature Combination for SWT . . . . .	46
8.12	Accuracy Comparison Across Feature Combination for Tomcat . . . . .	46
8.13	Top-K Accuracy with Varied Training Data Sizes . . . . .	49
A.1	Accuracy Comparison Between All Features for AspectJ . . . . .	62
A.2	Accuracy Comparison Between All Features for BIRT . . . . .	63
A.3	Accuracy Comparison Between All Features for Eclipse Platform UI . . . . .	63
A.4	Accuracy Comparison Between All Features for JDT . . . . .	64
A.5	Accuracy Comparison Between All Features for SWT . . . . .	64
A.6	Accuracy Comparison Between All Features for Tomcat . . . . .	65

# Chapter 1

## Introduction

Bug report assignment, the art of matching an open bug report to the developer best suited to process it, is a critical step towards localizing and fixing a bug. Bug assignees typically perform a variety of code reviews and changes to replicate the bug and verify the reported issue with the purpose of localizing it. With the explosion of the number of open bug reports and the natural increase in the number of teams and developers, matching bug reports to suitable developers has become challenging, especially because an incorrect assignment not only incurs a waste of a developer's time, but also adds the overhead of re-assigning the bug again. Compounding this problem is the rate at which bugs are reported. In 2013 alone, 3,389 bug reports were created for the Eclipse Platform product [40].

To cope with this expense, several studies have explored the design of automated techniques to recommend which developer should be processing a given bug report by mining and combining relevant information related to bug reports and the history of code changes [11], [12], [20]. Previous studies were clustered by Shokripour [28] according to the nature of information retrieved. Studies analyzing a developer's activities and experience are considered *activity-based*, while studies linking bug reports to a specific location in the code, and so to a potential developer, are considered *location-based*. A recent study by Tian et al. [32] presented a unified model that merges these activity-based and location-based features to benefit from their advantages, at the expense of increasing complexity through their combination. This approach utilizes a learning-to-rank algorithm for feature combination to generate a final ranking score. Another recent study by Lam et al. [16] used Deep Neural Networks (DNN) combined with a revised Vector Space Model (rVSM)

in a joint recommendation approach to combine activity-based and location-based features for the purpose of localizing bugs in the source code. Since learning-to-rank has shown promising results in comparison with state-of-the-art approaches for both bug localization and bug assignment [32], [41], and since a joint-recommendation approach outperformed learning-to-rank for the problem of bug localization at low k-values [16], a study applying these considerations to the problem of automated bug assignment could offer valuable insight and significant improvement over existing approaches.

In an effort to more completely profile the developers working on a project, we consider additional activity-based features. Activity-based features heavily rely on profiling developers using their contributions to the project in terms of code changes and previously handled bug reports. As the majority of developers' contributions are represented by their code changes, and as code changes represent the largest source of bugs, linking developers' code changes to the open bug reports has been proven to be a critical feature to improve the bug assignment process [1]. However, bug report descriptions are written in natural language, while the source code is represented by some programming language. As these two languages differ in context, representation and expression, this creates a lexical mismatch, hindering the efficiency of existing bug assignment approaches. Furthermore, developer commit messages for bug fixing activity have been used as a feature with positive results when addressing the problem of bug localization [26] [33], [37]. Therefore, we propose the use of developers commit messages as a new set of features for the problem of bug assignment. As shown in Chapter 5, commit messages are able to bridge the lexical gap as they are written using the same natural language of bug reports, besides containing valuable information that may not be captured by commit code changes.

To summarize, our key contributions are:

1. We reproduce the study of Tian et al. [32]. and perform a comparative study between this approach and an approach that encompasses an increased set of developer features. We also perform a comparative study between several ranking algorithms to identify the method of feature combination resulting in the highest accuracy.

2. We enrich activity-based features by using the information extracted from commit messages, as well as the Project API descriptions related to code developers have interacted with, as part of the domain knowledge that can be used to better profile developers for the purpose of bridging the lexical gap to enhance automated assignment for open bug reports.
3. We explore a joint recommendation technique combining Ordinal Regression and Learning to Rank in an effort to increase the accuracy of these ranking algorithms at low k-values.

The rest of this paper is organized as follows. Chapter 2 describes key information about the bug lifecycle, projects used, linking heuristics employed, and other import background knowledge to better understand this paper. Chapter 3 discusses related studies that have motivated our study. Chapter 4 formally describes our problem statement. Chapter 5 reviews the process in which we prepare our textual data as well as how we mathematically define and calculate our feature scores. Next, we examine the four methods of feature combination used in Chapter 6. We review our experimental setup, research questions, and evaluation metrics in Chapter 7. We then discuss our empirical evaluation and findings in Chapter 8. We examine threats to the validity of the study and motivate future work in Chapter 9, before concluding in Chapter 10.

# Chapter 2

## Background

In this chapter we review key information about software bugs, the bug lifecycle, and other information central to a thorough understanding of the problem space.

### 2.1 Bug Lifecycle Overview

Bruegge and Dutoit, in their textbook *Object-Oriented Software Engineering Using UML, Patterns, and Java*, define a software bug or defect as "a coding mistake that may cause an unintended or unexpected behavior of the software component" [3]. Bugs can be unintentionally introduced into a project for a variety of reasons, including project deadlines, lack of communication, simple programming errors, unclear requirements, and many others. One of the ways in which developers manage and track bugs is through the use of Issue Tracking Systems (ITS) such as BugZilla, Mantis, and JIRA. For the purposes of this study, we consider BugZilla to be our defining example of an ITS. BugZilla is a free and open source web-based bug tracking software available for most operating systems that has been utilized by thousands of projects and companies around the world, both as an out-of-the-box solution and as the framework for a personalized bug repository. It allows developers to track outstanding bugs, problems, issues, and change requests for many different types of software products. Figure 2.1 shows a bug report from the Eclipse Platform UI project that is being managed through BugZilla. In this view, we can see critical information regarding the bug's description, as well as when it was reported, its importance, and who is responsible for correcting the bug.

**Bug 384108 - JUnit view icon no longer shows progress while executing tests**

**Status:** VERIFIED FIXED **Reported:** 2012-07-03 03:39 EDT by Aviv Ben-Yosef ← ECA  
**Alias:** None **Modified:** 2014-02-06 06:29 EST ([History](#))  
**CC List:** 8 users ([show](#))

**Product:** Platform **See Also:**  
**Component:** UI ([show other bugs](#))  
**Version:** 4.2   
**Hardware:** All All

**Importance:** P3 major ([vote](#))  
**Target Milestone:** 4.4 M5   
**Assignee:** Daniel Rolka ← ECA  
**QA Contact:**

**URL:**  
**Whiteboard:**  
**Keywords:**

**Duplicates (1):** [148574](#) ([view as bug list](#))  
**Depends on:** [378408](#)  
**Blocks:**  
 Show dependency [tree](#)

---

**Attachments**  
[Add an attachment](#) (proposed patch, testcase, etc.)

Note  
 You need to [log in](#) before you can comment on or make changes to this bug.

Aviv Ben-Yosef <span style="color: red;">← ECA</span>	2012-07-03 03:39:25 EDT	Description
Build Identifier: Version: Juno Release Build id: 20120614-1722		
Before I upgraded to Juno this morning I used to happily run tests with the JUnit view minimized, and enjoy seeing the progress of the tests on it. Now I don't see any change on the icon until it passes (where a green check appears) or fails (where a red X appears).		
The animation of the little green/red squares, showing progress of the suite is gone, which is very frustrating and means I have to waste screen real estate having the junit view open (not optimal at all when coding on a small screen).		
Reproducible: Always		
Steps to Reproduce:		
1. Open Juno		
2. Run JUnit test		
3. See no progress		

Dani Megert <span style="color: green;">✓ ECA</span>	2012-07-03 10:08:39 EDT	Comment 1
It looks like the fix for <a href="#">bug-318866</a> is not complete: that fix only works if the JUnit view did not have focus when the stack got minimized.		
This should be considered for 4.2.1.		

Figure 2.1: Bug Report #384108 from Eclipse Platform UI as reported in BugZilla.

To better define and model the passage of a bug and its corresponding bug report through the different stages of being identified and corrected, a bug lifecycle, with different states and transitions, serves as a guideline to a project team working to correct these bugs [8]. The bug lifecycle tracks the progress of the bug through several steps across three broad phases: Initial Bug Management, Bug Triage, and Bug Localization and Correction. The default bug lifecycle model used by BugZilla sees the bug begin as an unconfirmed bug report. If a developer can confirm the bug's existence or if the bug receives enough public votes, an official bug report is created and assigned to a developer. That developer fixes the



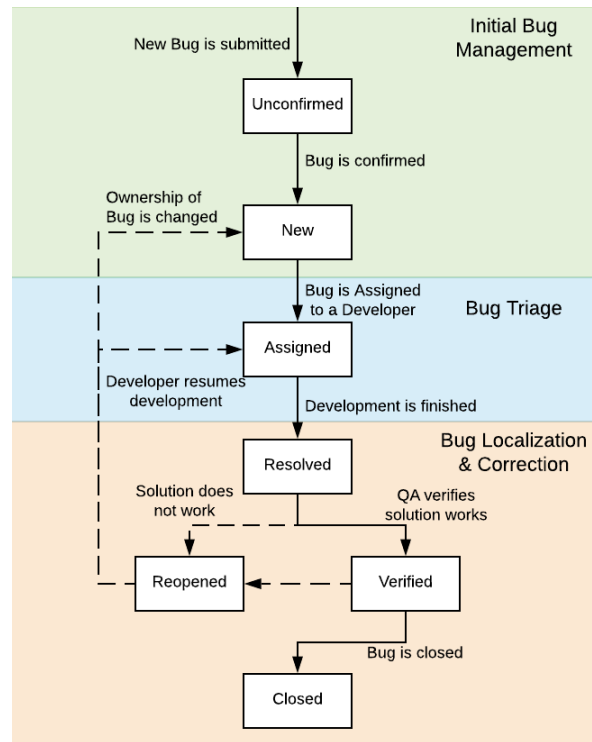

Figure 2.2: Lifecycle of a Bug

faulty code and submits their updates for testing. If the tests pass verification, the bug is marked as closed. If they fail the testing phase, the bug is reopened and the developer will repeat the bug fixing process. This process is represented in figure 2.2

Bug Localization is a software maintenance task in which a developer uses information from the bug report to identify and locate some section of the source code that is responsible for the generation of the bug. When approaching this as an Information Retrieval problem, we can consider extracted information from the bug report to be a query and the software project to be a problem space that contains the desired search result [21]. Likewise, Bug Triage is a software maintenance task where a bug report is assigned to a relevant developer who is suited to fix the bug. In traditional bug repositories, these bugs are manually triaged by a specialized developer or project manager. When approaching this as an Information Retrieval problem, we can consider extracted information from the bug report to be a query and the profiles and previous bodies of work of each developer with respect to the software

project to be the problem space that contains the desired search result [39].

## 2.2 Version Control Overview

A version control system enables multiple developers to work simultaneously on a single project. Each developer maintains their own copy of the files, and can make changes to these local files at their discretion. In this form, these changes do not affect the version of the code used for production (e.g. the code end users of the system interact with), nor do they impact the code that other developers are working with. When developers choose to share their changes with other members of their team, they "commit" their code to a centralized repository that other members of the development team have access to, along with a descriptive message summarizing any changes they have made. These changes can then be downloaded by other developers for incorporation into their local copy. Additionally, these changes can be added to the production version of the code, meaning that the developer's changes are now available to end users.

Version Control also enables multiple developers to simultaneously work on the same file. If different team members edit and commit different lines within the same file, the version control system will automatically integrate the most recent updates by each developer into that file in the centralized repository. In the event that users edit the same line and the updates are conflicting (e.g. each commit would overwrite changes made by the other), the system requests human assistance in reconciling the differences. Finally, the version control system maintains a log of changes and historical versions of a project. All changes made to the centralized repository, as well as the resultant state of the project, are saved and accessible at any time. Furthermore, these saved changes relay information about who edited a file, when they edited the file, and why they edited the file (per their descriptive commit message).

## **2.3 Project API Documentation Overview**

Application Programming Interface (API) Documentation is a set of technically written descriptions and instructions containing information about a given project. These documents detail information about functions, classes, return types, arguments, and other code tokens present in a project. This documentation, while technical in nature, is generally written in a natural language, such as English, and is designed to be human-readable, with the aim of empowering developers to better understand and utilize the project. Providing appropriate documentation is commonly considered a best practice for software engineering and can play a large role in making code more maintainable and reusable.

# Chapter 3

## Related Work

In this chapter, we highlight several approaches on bug triage and localization that profoundly influenced our approach. We have identified three previous studies as particularly relevant in guiding the direction of our approach. Tian et al. [32] and Ye et al. [41] offer exploratory studies into recommending developers to be assigned to a bug report. Lam et al. [16] introduce the use of Deep Learning in combination with Information Retrieval (IR) techniques to improve the accuracy of Bug Localization activities. A summary of each study is shown in Table 3.1.

Table 3.1: Feature Types Considered in Related Works

Study	Feature #	Feature Type
Ye et al. [41] (2014)	5	Code (& API) Similarity, Metadata
Tian et al. [32] (2016)	16	Code Similarity, Bug Report Similarity, Localization results, Metadata
Lam et al. [16] (2017)	6	DNN Relevancy, Code Similarity, Metadata

Ye et al. [41] implement an IR approach for bug localization that uses adaptive learning to derive weighted features based on the source files, bug history, and API descriptions. Using a learning to rank approach, the authors combine features to generate a list of scores indicating the likelihood that the code responsible for the bug exists in the given file. They employ a Vector Space Model and Cosine Similarity for ranking measures of textual similarity, extracting features similar to those used in this study. They calculate the similarity between a bug report and source code file, as well as between a bug report and source code

file enriched with API specifications for the classes and interfaces. The inclusion of API-enriched source code better allows the study to bridge the lexical gap, by annotating the source code (written in a programming language) with API descriptions written in natural language. The inclusion of natural language-based annotations allows for a more effective cosine similarity comparison between the annotated source code and the natural language text found in the bug report. They also implement four metadata features about the bug fixing history of the project. First, a collaborative filtering score that measures the textual similarity of a bug report to previous bug reports that have resulted in changes to a given file. Next, the similarity of class names mentioned in the bug report to class names in the source code file. Finally, the Bug Fixing Recency and Frequency for a file, measuring how recently (in months) a file has been changed and how many times within the last year a file has been changed as a result of bug fixing activity.

The model used in [41] is evaluated on the same dataset as used in this study. They compare their novel approach against four baselines: a standard VSM method based solely on textual similarity between bug reports and source code, the *Usual Suspects* method that recommends the top k most frequently fixed files [15], the BugLocator ranking tool [23], and the BugScout classifier tool [42]. They offer an empirical evaluation of their classifier as compared to these methods, as well as explore issues of future utility, training size and fold count impact, and runtime performance. Specifically, Ye et al. identify that as long as the most recent data was included in the training set, a larger training set did not have any positive impact on the accuracy of the classifier.

Tian et al. [32] introduce the current state-of-the-art approach for generating bug report assignee recommendations. They offer a novel unified learning to rank approach that leverages information from both developer activities and bug localization to capture 16 features representing a developer's suitability to fix a bug identified in a bug report. They then evaluate their results on over 11,000 bugs across three open source projects. Their assignee recommendation features are split into two domains: activity-based features and location-based features. They combine these features in a unified learning-to-rank approach that

generates a ranked list of the most suited developers to solve a bug report. They focus on evaluating their approach against existing activity-based [1], and location-based [29] approaches.

Activity-based approaches recommend a developer for a particular bug report based on how closely the developer's expertise aligns with the information identified in the report. We infer the developer's expertise based on previous developer activities within the project [1], [31]. Activity-based approaches consider information revolving around source code previously altered by the developer and bug reports previously completed by the developer. While mining this information offers valuable insight into the suitability of a developer to address a bug report, it fails to consider information linking a bug report to specific source code files [32]. Location-based approaches focus on identifying which source code file is most similar to the bug report and then inferring which developer is best suited to alter that source code file [28], [20], [11]. This approach relies on the completion of bug localization to match an incoming bug report to several potential buggy locations and assumes that developers who have recently touched or modified that code have substantial expertise in addressing that bug [32]. This approach more completely considers information correlating source code files and bug reports, but is heavily reliant on the implementation of an underlying localization technique and does not fully consider developer expertise based on the topic of the bug report [32].

Tian et al. created disjoint test and training sets out of 10 equally sized folds of bug reports (sorted temporally, with the oldest reports first) for each project. The ranking model was trained on the five folds prior to a test fold, and then evaluated on a test fold to generate a top-k ranking of developer recommendations. Results showed that their unified approach consistently outperformed the existing activity-based and location-based baselines. For top-1 accuracy, their model outperformed the activity-based baseline by 50.0% - 100.0% and location-based baseline by 11.1% - 27.0%. The average weight of each feature returned by the rankSVM tool was used to approximate the relative importance of each feature. However, this study does not identify if using a smaller training set comprised of recent

data is viable as explored in [41].

Lam et al. [16] implemented a joint-recommendation method employing a Deep Neural Network (DNN) along with a revised Vector Space Model (rVSM), a form of Information Retrieval (IR), to bridge the lexical gap and more accurately recommend files as potential locations for bugs, especially at lower k-values. Their approach, *DNNLOC*, extracts textual data from bug report and source code pairings, using the same features as [41]. They also add a DNN-based relevancy score that learns to semantically relate terms in a bug report and code or comment text without a reliance on measures of textual similarity, computing how semantically and contextually relevant a source code file might be to a bug report.

Once a vector of features has been built, the features are fed through a separate multi-layered Deep Neural Network to generate a single combined score that can be used to rank the candidate source files in order of likelihood that they contain the relevant buggy code. This approach was evaluated against the same dataset used by [41] and this paper. Their results indicated a universally higher accuracy at all k-values between 1 - 20 than all previously identified approaches, including [1], [15], [29], [41], and [42].

They also explore the impact of various components and parameters on the overall accuracy of the application. Varying the size of the DNN Relevancy Estimator showed that a hidden layer with over 1,000 nodes contributed to a higher and more stable accuracy. Additionally, they explored the effects of training data size on the accuracy of the application. The training dataset was split into 10 equally sized folds, with  $\text{fold}_{10}$  containing the most recent bug reports that were used for testing. Initially, only  $\text{fold}_9$  was used for training, with an additional fold being added to the training set for each test. This study revealed that increasing the size of the training set offered no benefit to the accuracy of the model, and that the most recent bug report data was the most useful for training.

# Chapter 4

## Problem Statement

As software programs become more pervasive and ubiquitous, the reliability requirements imposed upon a software system grow increasingly stringent. Continuous systems mandate a high percentage of system uptime, necessitating systems that can continue to function in the face of hardware or software errors as well as necessitating constant monitoring, rapid debugging, and potentially live patching. Even more dangerous are undetected bugs that incorrectly alter the results of a system. Historically, the use of incorrect results caused by undetected bugs has led to catastrophes in mission-critical [5] and safety-critical systems [18].

In any software project of sufficient size and complexity, bugs are inevitable. Project deadlines, ignorance of best coding practices, and developer turnover can all increase the likelihood that a bug is created. Furthermore, software documentation is frequently incomplete or out of date, as systems can be complex structures assembled by different components, and projects can grow so large or complex that any one developer rarely has knowledge of the entire system [9]. As a result, software development teams can be required to spend a great deal of time and effort fixing bugs. Hill et al. report that a large majority of software cost comes exclusively from activities related to the evolution and system maintenance of existing source code [10]. Specifically, the process of identifying, localizing, and correcting software defects is an expensive, time consuming, and labor-intensive task. Bug Localization and Bug Triage are two critical components of this process, but are themselves manual, labor intensive, and require a great deal of expertise with regards to both the software project and the software team. Additionally, the varying quality of



bug reports submitted during the development lifecycle of a project can make efficiently locating, assigning, and addressing these bugs even more difficult.

In order to lessen the cost of these processes and reduce human debugging time, several studies have attempted to automate bug triage and localization [16], [32], [40], [41]. However, these studies have historically lacked the accuracy necessary for wide-spread commercial adoption. Adapting these existing approaches to more completely consider the information available to connect a bug report and the developer most suited to address it, as well as exploring recommendation techniques to increase accuracy at lower k-values, offers the potential to improve the accuracy and usability of the approach to a satisfactory level.

# Chapter 5

## Feature Engineering

In this chapter, the preprocessing and feature extraction approach is detailed. First, we introduce our overall approach to generating developer rankings. We then review all preprocessing work performed on the text and explore the text comparison algorithm used, before introducing all features used to connect a developer with a bug report and the manner in which we normalize variance in data ranges.

### 5.1 Feature Use Overview

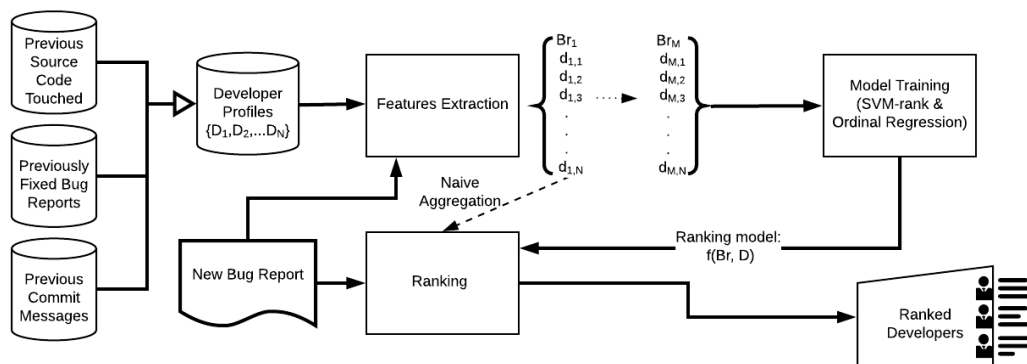

Figure 5.1: Approach Overview.

Figure 5.1 provides an overview of the process used to create our ranking models and generate a ranked list of developers for a given bug report. In this process, a set of developer profiles, composed of previous source code touched, previously fixed bug reports, previous commit messages, and other bug fixing metadata, are created and mined to generate a set of 22 features that can be used to rank developers in order of suitability for working

on a bug report. For the learning-to-rank, ordinal regression, and joint-recommendation approaches described in Chapter 6, feature scores are extracted from each historical Bug Report-Developer Profile pairing and used to train the ranking model (this training does not occur in the Naive Aggregation approach). When a new Bug Report enters the system, its feature data is extracted and is ranked either by the trained ranking model or via naive aggregation. This creates a list of developers ranked in order of suitability to work on that bug report. The remainder of this chapter will describe the manner in which we extract information from the project materials to create developer profiles and how we mathematically define the features used in our ranking models. Chapter 6 describes the methods in which we combine these features to create and train the models used to generate rankings for each developer.

## 5.2 Text Preprocessing

Before feature extraction, all textual data was preprocessed using standard steps to tokenize, cast to lowercase, remove stop words from, and stem the input. Tokenizing is the process of parsing natural text data into tokens - a series of delimited strings that contain no white spaces, punctuation marks, and other non-alphanumeric characters. Casting the text to lowercase allows for more effective comparison of text by removing any case-specific considerations. Stop Words are a set of commonly used words that have no value in IR or search queries. Most search engines, for example, are programmed to ignore such words. We employed the Python NLTK standard English stopword list, which includes common pronouns such as "I", "our", and "their", as well as other non-descriptive words such as "are", "these", and "the." Stemming is the process of reducing inflected or derived words to their base form. As an example, both "fixed" and "fixing" can be stemmed to "fix." The standard Porter stemming algorithm [14] in Python's NLTK package was used to perform this process.

Additionally, code entities in the Bug Report text that were written in camel case were split into their component words based on their capitalization. These tokens were also

tokenized, cast to lowercase, and stemmed, or discarded if they were present in the list of stop words. These tokens were appended to the end of the bug report description. For example, the code token *ValuePropertyDetailMap* would be split into "value", "property", "detail", and "map" (which are each then stemmed and appended). The initial token is not removed from the bug report. This allows the text comparison algorithm detailed in section 5.3 to recognize components within similar code tokens that are not expressed in natural language.

### 5.3 Text Comparison Algorithm

In order to numerically measure the similarity between two text documents, we must consider the cosine similarity score. This study utilizes the same cosine similarity metric as defined in [32]. The similarity between a given bug report,  $Br$ , and a given developer,  $D$ , (i.e.  $\phi(Br, D)$ ) is calculated through a series of cosine similarity comparisons between two documents -  $Cosine(f_1, f_2)$ , where  $f_1$  and  $f_2$  are both text-based files. These files could include bug reports, source code, or commit messages. This function transforms each document into a vector of weight, where each word is an element of the vector. We calculate the weight of a word using TF-IDF, or term frequency-inverse document frequency, a common method of assigning weights in IR [22]. TF-IDF essentially measures how "important" a word is to a given document and is computed as:

$$w_{term,doc} = TF_{term,doc} \times IDF_{term} \quad (5.1)$$

In this equation, the *Term Frequency*, the number of times the term appears in the document, is multiplied by the inverse of the *Document Frequency*, the number of documents that contain the term. We then use the weight vectors,  $w$ , of each document to compute their cosine similarity:

$$Cosine(f_1, f_2) = \frac{\vec{f}_1 \cdot \vec{f}_2}{\|\vec{f}_1\| \|\vec{f}_2\|} \quad (5.2)$$

In this equation,  $\vec{f}_1$  and  $\vec{f}_2$  are the vectors obtained from each compared file,  $\cdot$  is the vector dot operation, and  $\|\vec{f}_1\|$  and  $\|\vec{f}_2\|$  are the size of each vector.

## 5.4 Feature Extraction

This section presents how features are extracted from the combination of source files, bug reports and commit messages. Both activity-based and location-based features are used based on Tian et al. [32] as discussed in section 3. However, we also include a comparison based on the bug report and the developers' previous commit messages to capture an added dimension of developer suitability. See table 5.1 for a grouping and overview of all features used to generate bug report assignee recommendations.

Table 5.1: Features used in the Ranking Model

Feature	Group	Formula
$\phi_1$	Bug Report-Code Similarity	$\max(\text{Cosine}(Br, s)   s \in D_{CodeCorpus})$
$\phi_2$		$\text{avg}(\text{Cosine}(Br, s)   s \in D_{CodeCorpus})$
$\phi_3$		$\text{sum}(\text{Cosine}(Br, s)   s \in D_{CodeCorpus})$
$\phi_4$		$\text{Cosine}(Br, D_{MergedCode})$
$\phi_5$		$\max(\text{Cosine}(Br, a)   a \in D_{APICorpus})$
$\phi_6$		$\text{avg}(\text{Cosine}(Br, a)   a \in D_{APICorpus})$
$\phi_7$		$\text{sum}(\text{Cosine}(Br, a)   a \in D_{APICorpus})$
$\phi_8$		$\text{Cosine}(Br, D_{MergedAPI})$
$\phi_9$	Bug Report-Bug Report Similarity	$\max(\text{Cosine}(Br, b)   b \in D_{BugCorpus})$
$\phi_{10}$		$\text{avg}(\text{Cosine}(Br, b)   b \in D_{BugCorpus})$
$\phi_{11}$		$\text{sum}(\text{Cosine}(Br, b)   b \in D_{BugCorpus})$
$\phi_{12}$		$\text{Cosine}(Br, D_{MergedBugs})$
$\phi_{13}$	Bug Fixing Metadata	$ br_{Oneyear}(Br, D) $
$\phi_{14}$		$(diff^{MTH}(Br.date, last(Br, D).date) + 1)^{-1}$
$\phi_{15}$	Location-Based Features	$\text{Max}_{C_i \in TopK}(\text{Cosine}(C_i, D_{MergedCode}))$
$\phi_{16}$		$\text{Avg}_{C_i \in TopK}(\text{Cosine}(C_i, D_{MergedCode}))$
$\phi_{17}$		$\begin{cases} 1, & \text{if } D \text{ has touched } C_i \in TopK \\ 0, & \text{otherwise} \end{cases}$
$\phi_{18}$		$ Br.files \cap D_{CodeCorpus} $
$\phi_{19}$	Bug Report-Commit Similarity	$\max(\text{Cosine}(Br, r)   r \in D_{CommitCorpus})$
$\phi_{20}$		$\text{avg}(\text{Cosine}(Br, r)   r \in D_{CommitCorpus})$
$\phi_{21}$		$\text{sum}(\text{Cosine}(Br, r)   r \in D_{CommitCorpus})$
$\phi_{22}$		$\text{Cosine}(Br, D_{MergedCommits})$

### 5.4.1 Activity-Based Features

This subsection includes features that are calculated based on the bug fixing activities of developers, including previously touched code and any relevant API descriptions, as well as previously solved bug reports.

#### Bug Report-Code Similarity

Bug Report-Code Similarity refers to features that measure the similarity between a bug report and code that a developer has interacted with in the past year. We limit the code considered to the past year to compare the bug report to more relevant code changes from the developer. Changes made by a developer over one year ago are likely to be far less relevant to the developer's expertise than more recent changes. Furthermore, if a developer has not interacted with some file in over a year, it is likely that the source file may have been significantly altered since the developer last interacted with it. If the bug report is similar to code that the developer has interacted with, they are more likely to be familiar with the programming terms and entities referenced in the bug report, as well as the code that would require alterations to satisfy the bug report. For the purposes of this study, we define developer interaction as any action resulting in that file's inclusion in a commit, including editing, addition, or deletion. For comparison, we aggregate the summary and description into one document for each bug report,  $Br$ . The first four features are defined as follows:

$$\phi_1(Br, D) = \max(\text{Cosine}(Br, s) | s \in D_{CodeCorpus})$$

$$\phi_2(Br, D) = \text{avg}(\text{Cosine}(Br, s) | s \in D_{CodeCorpus})$$

$$\phi_3(Br, D) = \text{sum}(\text{Cosine}(Br, s) | s \in D_{CodeCorpus})$$

$$\phi_4(Br, D) = \text{Cosine}(Br, D_{MergedCode})$$

In the above equations,  $Br$  is the summary and description of the bug report.  $s$  is each source file within  $D_{CodeCorpus}$  where  $D_{CodeCorpus}$  is the set of source code files in the project touched by the developer,  $D$ , during any development activity. For  $\phi_{1-3}$  we calculate the cosine similarity for each source file and compute the Maximum, Mean, and Sum as feature

values. To align the range of  $\phi_3$  with the other features used in this study, we implement feature scaling as detailed in section 5.5. For  $\phi_4$ , we merge all touched source code for the developer,  $D$ , into one document,  $D_{MergedCode}$ , and compute its cosine similarity with  $Br$  as a feature.

### **Bug Report-API Similarity**

Bug Report-API Similarity refers to features that measure the similarity between a bug report and the API documentation of classes and interfaces referenced in the source code that a developer has interacted with in the past year. Typically, the majority of text in a bug report is expressed in natural language (e.g., English), whereas most of the content in source code files is expressed in a programming language (e.g., Java). Cosine similarity functions only return non-zero values for tokens that are explicitly present in both documents, meaning that comparing two documents expressed in different forms or languages may not result in a valuable feature. This challenge in comparing bug report text and source code has been termed the *lexical gap*. In this scenario, bug reports and source code are only considered capable of bridging the lexical gap when the source code is annotated with extensive, comprehensive comments or the bug report contains fragments of code matching the source file, such as class names, method names, or a stack trace. However, "in practice, it is often the case that the bug report and a relevant buggy file share very few tokens, if any" [40].

To help bridge the lexical gap, we consider a feature set that measures the similarity between a bug report and the natural language-based API specifications of the classes and interfaces used in the source code that a developer has interacted with in the past year. For each source file, we extract references to classes and interfaces from "import" statements and in-line references. Using the project API specification, we extract the natural language descriptions of the referenced classes to create a document for each source file in

the project. This technique has been previously employed in [41] to better connect bug reports and source files to address the problem of bug localization. These features are defined as follows:

$$\phi_5(Br, D) = \max(\text{Cosine}(Br, a) | a \in D_{APICorpus})$$

$$\phi_6(Br, D) = \text{avg}(\text{Cosine}(Br, a) | a \in D_{APICorpus})$$

$$\phi_7(Br, D) = \text{sum}(\text{Cosine}(Br, a) | a \in D_{APICorpus})$$

$$\phi_8(Br, D) = \text{Cosine}(Br, D_{MergedAPI})$$

In the above equations,  $Br$  and  $D$  are defined as previously described in Bug Report-Code Similarity.  $a$  is each set of API documentation for a source file within  $D_{APICorpus}$  where  $D_{APICorpus}$  is the set of all API documentations for each source file touched by the developer with in the past year. To align the range of  $\phi_7$  with the other features used in this study, we implement feature scaling as detailed in Section 5.5. For  $\phi_8$ , we merge all referenced API documentation for the developer,  $D$ , into one document,  $D_{MergedAPI}$ , and compute its cosine similarity with  $Br$  as a feature. These features are calculated in the same manner as  $\phi_{1-4}$ .

### **Bug Report-Bug Report Similarity**

Bug Report-Bug Report Similarity refers to features related to the similarity between a given bug report and any bug reports that the developer has fixed prior to the bug report being filed. Tokens appearing in bug reports that have been historically fixed by a developer may offer insight into their areas of expertise. If the tokens in the current bug report are similar to the historical tokens, the bug in question may fall within the developer’s areas of expertise. These features are calculated in the same manner as  $\phi_{1-8}$ . Again, the summary and description of the bug report are combined into one document for textual similarity



computation. These features are defined as follows:

$$\phi_9(Br, D) = \max(\text{Cosine}(Br, b) | b \in D_{BugCorpus})$$

$$\phi_{10}(Br, D) = \text{avg}(\text{Cosine}(Br, b) | b \in D_{BugCorpus})$$

$$\phi_{11}(Br, D) = \text{sum}(\text{Cosine}(Br, b) | b \in D_{BugCorpus})$$

$$\phi_{12}(Br, D) = \text{Cosine}(Br, D_{MergedBugs})$$

In the above equations,  $Br$  and  $D$  are the same as for Bug Report-Code Similarity.  $b$  is each bug report within  $D_{BugCorpus}$  where  $D_{BugCorpus}$  is the set of bug reports marked as "RESOLVED FIXED", "VERIFIED FIXED", or "CLOSED FIXED" that list that developer as the author of the commit that resolved the bug report. To align the range of  $\phi_{11}$  with the other features used in this study, we implement feature scaling as detailed in Section 5.5. For  $\phi_{12}$ , we merge all previous bug reports for the developer,  $D$ , into one document,  $D_{MergedBugs}$ , and compute its cosine similarity with  $Br$  as a feature.

### Bug Fixing Metadata

Bug Fixing Metadata refers to two features related to the bug fixing history of a project - bug fixing frequency and bug fixing recency. Tian et al. assume that a developer that has fixed a large number of bugs is typically knowledgeable about the project and could potentially be more suitable for fixing a bug than a less experienced developer [32]. To quantify this, we include bug fixing frequency as a feature that aggregates the count of Bug Reports a developer has completed for a project over the past year. To align the range of this feature with the other features used in this study, we implement feature scaling as detailed in Section 5.5. This is defined below:

$$\phi_{13}(Br, D) = |br_{Oneyear}(Br, D)|$$

Similarly, a developer who has fixed bugs recently is also typically knowledgeable about the current state of the project and could be more suited for fixing a bug than a developer who has not interacted with the project for some time. To quantify this, we include

bug fixing frequency as a feature that calculates the inverse of the difference between the dates of the given bug report and the developer’s most recently fixed bug report in months (rounded down). In this equation we use an inverse to more harshly penalize developers that have not interacted with the project in a longer span of time. This is defined below:

$$\phi_{14}(Br, D) = (diff^{MTH}(Br.date, last(Br, D).date) + 1)^{-1}$$

## 5.4.2 Location-Based Features

This subsection includes features that are calculated based on the location of the code that likely contains the bug identified in the bug report. To perform this bug localization process, we use the learning to rank approach employed in [41]. While the DNN-based localization approach used in [16] has offered higher accuracy in identifying potentially buggy files, we elected to match the approach used in [32] to allow for a more valid comparison. Implementing Lam et al.’s Localization approach has been left as a future work for this study.

### Potential Buggy Code-Related Code Similarity

To calculate these features, we perform bug localization to generate a list of the 10 source code files that are most likely to contain code relevant to the submitted bug report. If the developer has worked on the files where the bug is most likely to be or has worked on other similar files, they may be well suited to addressing the bug. We then perform additional cosine similarity calculations to identify the similarity between code the developer has worked on within the past year and the likely buggy locations. These functions are defined below:

$$\phi_{15}(Br, D) = MAX_{C_i \in TopK}(Cosine(C_i, D_{MergedCode}))$$

$$\phi_{16}(Br, D) = AVG_{C_i \in TopK}(Cosine(C_i, D_{MergedCode}))$$

In the above equations, *TopK* is the top-k source code files identified by the bug localization technique to be most likely to contain the code causing the bug described in *Br*. For this study, *K* is set to 10.  $C_i$  is each of the top-k most likely source files to contain the bug and  $D_{MergedCode}$  is one document containing all touched source code for the developer within the past year. We compute the cosine similarity between each file from the localization and the merged corpus of all code touched by a developer. We return the maximum and average value as features.

### **Touched Potential Buggy Files**

This feature is a simple indication of whether or not the developer has touched a file within the top 10 files returned from bug localization used in  $\phi_{15}$  and  $\phi_{16}$ . The feature is defined below:

$$\phi_{17}(Br, D) = \begin{cases} 1, & \text{if developer } D \text{ has touched } C_i \in TopK \\ 0, & \text{otherwise} \end{cases}$$

### **Touched Mentioned Files**

For some bug reports, developers include the names of some classes or files, either within text or within the form of a stack trace. To capture this, we include the count of files mentioned in the bug report that a developer has previously touched as a feature, defined below:

$$\phi_{18}(Br, D) = |Br.files \cap D_{CodeCorpus}|$$

In the above equation,  $Br.files$  is the set of source code file names appearing in the Bug Report,  $Br$ , and  $D_{CodeCorpus}$  is the set of source code files touched by the developer,  $D$  to fix previous bugs. To align the range of this feature with the other features used in this study, we implement feature scaling as detailed in section 5.5.

### 5.4.3 Developer Profile-Based Features

This subsection introduces the rationale behind using commit messages as a potential source of information for recommending developer assignment and then details how this information is calculated and represented as features.

A typical bug report contains a mix of structured information, composed of a natural language text describing the observed anomaly and potential code elements that are involved, (e.g. method calls, identifiers, file names, and stack traces). As a bug-fixing commit typically contains a similar description, relevant properties can be extracted to characterize how the bug was processed. These properties may not necessarily be reflected in the source code classes and methods being updated by the bug-fixing commit. To give an illustrative example, we consider the following bug report and its fixing-commit in Figure 5.2.

As shown in Figure 5.2, the developer describes the bug using natural language along with mentioning classes and software versions. Various features correlate this bug report to file changed in its fix-commit. However, in this example the changed class is only innovating the method with the violated property, and thus its similarity with the bug report would be relatively low. Whereas, the examination of the commit message log reveals a stronger connection between the bug report and the message’s description. For instance both texts contain similar repeated keywords such as *extension* and *disabled icons*, increasing their similarity, which enhances the effectiveness of any IR-based approaches [34], [36]. Therefore, we propose features capturing the similarity between bug reports and commit messages in the following subsection.

**Bug Description:** I have declared a toolbar menu contribution command, and the "disabledIcon" property does not seem to be respected. I even tried the org.eclipse.ui.commandImages extension point to verify if the "disabledIcon" from that extension (and not org.eclipse.ui.menus) would be respected, but still no success. What I get on my GUI is the automatically generated version of my disabled icons, which for some images do not look good so I had generated them myself. While running on top of Eclipse 3.7.2 everything looked fine, but now I cannot get it to work.

**Bug-Fix Commit Log:** Bug 384056 - Disabled icons not being used from extension

**Files Changed in the Bug-Fix Commit:**  
 bundles/org.eclipse.ui.workbench/Eclipse  
 UI/org/eclipse/ui/internal/menus/  
 MenuAdditionCacheEntry.java

Figure 5.2: Bug Report #384056 from Eclipse UI.

### Bug Report-Commit Log Similarity

Version history and commit logs have frequently been used in development activity-related data mining and several previous studies have used them in relating bug reports to developers [2], [30], [35], [38]. As stated above, a developer's commit message text can offer a brief summary of the code written or work performed. As a result, these logs can contain text that may be valuable in matching developers with a bug report. To accommodate this extra dimension of developer suitability, we have introduced four additional cosine similarity features comparing a bug report with documents composed of the developer's commit messages. These features are calculated identically to  $\phi_{1-4}$ ,  $\phi_{5-8}$ , and  $\phi_{9-12}$ , using the commit logs associated with commits submitted by the developer prior to the creation of the Bug Report as the document. To avoid falsely inflating similarity measures, any references to the corrected bug in the commit text (e.g. "Bug 384056" or "Fix for Bug 384056") were stripped from the text prior to any comparison. Commits submitted without a summarizing commit message were not included in this document. These features are defined

as follows:

$$\phi_{19}(Br, D) = \max(\text{Cosine}(Br, r) | r \in D_{CommitCorpus})$$

$$\phi_{20}(Br, D) = \text{avg}(\text{Cosine}(Br, r) | r \in D_{CommitCorpus})$$

$$\phi_{21}(Br, D) = \text{sum}(\text{Cosine}(Br, r) | r \in D_{CommitCorpus})$$

$$\phi_{22}(Br, D) = \text{Cosine}(Br, D_{MergedCommits})$$

In the above functions, the Cosine function,  $Br$ , and  $D$  are identical to  $\phi_{1-12}$ .  $r$  is each commit message within  $D_{CommitCorpus}$  where  $D_{CommitCorpus}$  is the set of version control commit messages previously submitted by the developer during development activity.  $D_{MergedCommits}$  contains every prior commit message for that developer. The Cosine Similarities scores are computed in the same way as  $\phi_{1-12}$ . To align the range of  $\phi_{21}$  with the other features used in this study, we implement feature scaling as detailed in section 5.5.

## 5.5 Feature Scaling

Features with a wide range of values can be detrimental when training machine learning algorithms. Many algorithms tend to perform better when there is not a wide variation in the range of values for a given feature and when most features have a similar range and scale. Feature scaling normalizes all features to the same scale so that they become more comparable with each other. For some feature  $\phi$ , let  $\phi_{min}$  and  $\phi_{max}$  be the minimum and maximum observed values for that feature in the training dataset. A feature may also have values present in the testing set that are larger than the observed maximum or smaller than the observed minimum found in the training set. To accommodate these scenarios, we scale the features in the testing and training dataset as follows:

$$\phi_{Scaled} = \begin{cases} 0, & \text{if } \phi < \phi_{min} \\ \frac{\phi - \phi_{min}}{\phi_{max} - \phi_{min}}, & \text{if } \phi_{min} \leq \phi \leq \phi_{max} \\ 1, & \text{if } \phi > \phi_{max} \end{cases} \quad (5.3)$$

# Chapter 6

## Feature Combination

This chapter reviews the four methods we have chosen to combine the features we have extracted from the bug fixing data. Choosing the appropriate method of feature combination can be as important as choosing appropriate features. More sophisticated methods of feature combination can be trained to identify the importance of certain features and apply a weighting factor to emphasize the ones that have been identified as important to the accuracy of the model. We have selected four methods of combination to provide a more complete analysis of our features - naive aggregation, a learning to rank approach, an ordinal regression-based approach, and a joint-recommendation approach utilizing both learning to rank and ordinal regression.

### 6.1 Naive Aggregation

To illustrate the benefits offered by the use of ranking algorithms, we include a Naive Aggregation of the features as a baseline for comparison with our other models. Feature Score aggregation was used in earlier studies [24], [27], [43] where the number of features is limited, so they are either weighted using trial and error or simply summed to generate a final ranking value. No weights are applied to any of the features. The bug report/developer pairings are then ranked in descending order by this final score. This approach is shown below, where  $\phi_i(r, s)$  is each feature score and  $k$  is the total number of features:

$$f(Br, D) = \phi(Br, D) = \sum_{i=1}^k \phi_i(r, s) \quad (6.1)$$

## 6.2 Learning to Rank

We include a learning-to-rank approach for combining features to allow for effective comparison with previous results. This approach was used in [32], [40], and [41] to generate their final ranking score. In this approach, a ranking model is trained using historical data that is labeled with the correct developer/bug report pairing. The model uses these values to identify which features are of the most importance to the correct bug report/developer pairings and calculates corresponding weights for each feature to emphasize the features that most contribute to a correct ranking and minimize the ones that do not. Each feature value in the test set is then multiplied by its corresponding weight to generate a final ranking value. The bug report/developer pairings are then ranked in descending order by this final score. This approach, as defined by [41], is shown below, where  $\phi_i(r, s)$  is each feature score,  $w_i$  is that feature's rank assigned by the learning to rank model, and  $k$  is the total number of features:

$$f(Br, D) = w^T \phi(Br, D) = \sum_{i=1}^k w_i * \phi_i(r, s) \quad (6.2)$$

## 6.3 Ordinal Regression

To provide an additional dimension of comparison, the features extracted from each dataset were used as input into an Ordinal Regression model in the Microsoft Azure Machine Learning Studio. An Ordinal Regression model was selected due to its suitability in problems involving predicting and ordering ranked values. Predicting an ordinal ranking is a specialized task differentiated from predicting values on a continuous scale by the lack of an intrinsic scale in the numbers representing rank order. For example, predicting students' test scores could be performed by a standard regression model, but a prediction of their class ranking would require an ordinal regression model. The model treats a ranking problem as a series of related classification problems. To address this, the algorithm uses an extended binary classification model for each rank to indicate if the value should be ranked above or below each rank.



A Two-Class Boosted Decision Tree classifier is used as the underlying binary classification algorithm. This is an ensemble learning method where ensuing trees correct for the errors of previous trees before using the entire ensemble of trees to make a joint prediction. Boosted decision trees are typically appropriate in instances where the features are somewhat related and where many more examples are present than features - both conditions that our dataset meets. Additionally, this algorithm is suited to a wide variety of machine learning tasks, at the cost of being one of the more memory-intensive approaches. Furthermore, Anvik et al. [1] have used a Decision Tree classifier to address bug localization. Given this information, we feel this algorithm is the most suitable classifier for this study. This approach, as defined by [19], is shown below:

$$r(x) = 1 + \sum_{k=1}^{K-1} \mathbb{I}[f(x, k) > 0] \quad (6.3)$$

## 6.4 Joint Recommendation

Evaluations of early trials on the Eclipse UI dataset indicated that the Ordinal Regression approach, while less accurate overall than the learning to rank approach, correctly identified a noteworthy amount of correct developer-bug report pairings that were missed at low k-values by the learning to rank approach. In an effort to increase the accuracy of the ranking algorithm at low k-values, the viability of a joint recommendation technique is explored. In this technique, the results of the ordinal regression algorithm will be used to create another feature for use in the learning to rank approach. For a given developer, if the developer is the top-ranked ( $k=1$ ) recommendation in the ordinal regression approach, the value will be 1, otherwise the value will be 0. This feature is then used as a component of the learn to rank approach described in section 6.2. This feature is defined as follows:

$$\phi_{23}(Br, D) = \begin{cases} 1, & \text{if developer } D \text{ is the ranked first by Ordinal Regression} \\ 0, & \text{otherwise} \end{cases}$$

# Chapter 7

## Experimental Methodology

In this chapter, we begin by presenting our research questions. We then introduce the dataset used and review several corrections and filters applied to the data. Next, we enumerate the database structure and linking heuristic used to connect developer commit messages with bug reports. Finally, we review the experimental setup and evaluation metrics.

### 7.1 Research Questions

In attempting to identify if we can more accurately assign bug reports to software developers for a project, we present the following research questions:

1. Does a model that considers textual similarity between bug reports and version control commit messages, as well as between bug reports and project API specifications, achieve higher accuracy than a model without those features for the problem of automated bug assignee recommendation?
2. Which method of feature combination for our features (between naive aggregation, learning-to-rank, and ordinal regression) is most suitable for bug triage?
3. Does a joint recommendation approach offer superior accuracy as compared to its component parts?
4. Which features are most important to the accuracy of our model?
5. Does the size of the training dataset have a significant impact on the accuracy of the classifier for the problem of automated bug assignee recommendation?

For RQ1, we compare accuracy results for the most recent fold of bug report data between a model using just the features used by Tian et al. in [32] and a model using those features in addition to our new features (i.e.  $\phi_{5-8}$  and  $\phi_{19-22}$ ). We use the SVM-rank tool to implement a learning to rank-based training for our model, as is performed in [32]. For RQ2, we take the set of features that performs better from RQ1 and apply the three different methods of feature combination discussed in section 6 and compare the accuracy results across each of the three approaches. For RQ3, we compare the joint recommendation approach discussed in section 6.4 to the approaches examined in RQ2. For RQ4, we measure the relative importance of each feature by comparing the weights assigned by the learning-to-rank tool to each feature in the model generated for our feature set. For RQ5, we vary the number of folds used for training for each dataset and examine the impact of smaller training sizes on overall classifier accuracy. We track the accuracy of the learning-to-rank model using the best performing feature set from RQ1 at k values of 1, 5, 10, and 20 across increasingly small training datasets. With each iteration, the fold containing the oldest data will be discarded until  $fold_9$  (the most recent bug fixing data prior to the test set) is the only fold used for training.

## 7.2 Data Collection and Filtration

To allow for effective comparison, we used the same dataset used by Lam et al. & Ye et al., and partially overlap with the dataset used by Tian et al. [16], [32], [41]. This dataset consists of bug reports, commit logs, and project sources of six open source java projects: AspectJ, Birt, Eclipse UI, JDT, SWT, and Tomcat. A brief description of each project is available in section 7.3. All the bug reports, source code links and buggy files, API documentation, and the oracle of bug-to-file mappings are all publicly available<sup>1</sup> thanks to Ye et al.

---

<sup>1</sup><http://dx.doi.org/10.6084/m9.figshare.951967>

Table 7.1: Subject Projects Considered for Evaluation.

Subject Projects [41]						
Project	Time Range	# Reports	# Files	# API entries	# Devs	# Commits
AspectJ	03/02 - 01/14	659	4,439	54	8	7,608
Birt	06/05 - 12/13	4,691	6,841	957	57	32,210
Eclipse UI	10/01 - 01/14	6,670	3,454	1,314	122	28,621
JDT	10/01 - 01/14	6,528	8,184	1,329	37	27,977
SWT	02/02 - 01/14	4,266	2,056	161	31	27,185
Tomcat	07/02 - 01/14	1,075	1,552	389	18	20,665

For the purposes of this study, we only considered bug reports that were marked "RESOLVED FIXED", "VERIFIED FIXED", or "CLOSED FIXED" for both training and testing. Furthermore, we discard any bug reports that are linked to multiple git commits, as it is unclear which fixed files and commits are relevant [41]. Additionally, we discard any bug reports that do not have a java file present in their list of corrected files, as these are considered to be nonfunctional reports [4].

Manual inspection of the data revealed that several developers had entered code under multiple usernames over the course of several of the projects. These multiple usernames occurred for several reasons, including switching between a username and a display name ("*obesedin*" → "*Oleg Besedin*"), adding a middle name to a display name ("*Markus Kuppe*" → "*Markus Alexander Kuppe*"), or simple typos ("*Chris Goldthorpe*" → "*Chris Goldthorp*"). Each instance of duplicate usernames was manually verified by ensuring that each account shared a common username or email address before correction. These corrections removed one extraneous developer profile from the AspectJ Project, nine from the BIRT project, and eleven from the Eclipse UI Project.

### 7.3 Projects Used

For this study, we considered benchmark datasets from six open source Java projects. These projects offer varying time ranges, file counts, and number of developers working on the project. Table 7.2 details information about each project. Several studies have previously

utilized this set of benchmark datasets to address bug localization [40], [41]. This dataset partially overlaps with the dataset used in [32] to address bug triage. All of these projects use BugZilla as their issue tracking system and Git as a version control system. The bug reports, source code, and API specifications for each project are all publicly accessible. The projects considered are as follows:

- AspectJ<sup>2</sup>: an aspect-oriented programming extension for Java.
- Birt<sup>3</sup>: an Eclipse-based business intelligence and reporting tool.
- Eclipse Platform UI<sup>4</sup>: The user interfaces for the Eclipse integrated development platform.
- JDT<sup>5</sup>: A suite of Java development tools for Eclipse.
- SWT<sup>6</sup>: A widget toolkit for Java.
- Tomcat<sup>7</sup>: A web application and servlet container.

## 7.4 Database Structure

BugZilla stores different information relevant to the creation, processing, and completion of a bug report as it moves through the bug lifecycle. For each of the above projects, several data points were mined for each bug report to create the benchmark dataset. The information from BugZilla was augmented by mapping the report to the file changes and commit that was responsible for their correction. This was performed prior to this study using heuristics proposed by Dallmeier and Zimmerman in [4] as described in Section 7.5. The relevant information extracted for each bug report is enumerated below:

---

<sup>2</sup><http://eclipse.org/aspectj>

<sup>3</sup><https://www.eclipse.org/birt/>

<sup>4</sup><https://projects.eclipse.org/projects/eclipse.platform.ui>

<sup>5</sup><http://www.eclipse.org/jdt>

<sup>6</sup><http://www.eclipse.org/swt>

<sup>7</sup><http://tomcat.apache.org>

- Bug id: The six digit ID number used to identify the bug in BugZilla
- Summary: A brief message summarizing the detected bug
- Description: A longer message with more specific information about the bug
- Report time: The date and time the bug report was created
- Reporter: The developer or user who reported the bug
- Assignee: The developer who was assigned the task of fixing the bug
- Status: The working status of the bug, indicating where in the bug lifecycle it is
- Commit: The commit hash matching the Git commit that resulted in the bug being corrected
- Author: The developer who submitted the Git commit that resulted in the bug being corrected
- Commit time: The time at which the correcting commit was submitted
- Log: The commit message attached to the correcting commit
- Files: The files that were changed in the correcting commit

## 7.5 Linking Heuristic

In order to establish our ground truth - that is, which developer submitted the commit that resulted in the correction of the bug identified in a bug report - we employ the linking heuristic used by Dallmeier and Zimmerman to connect a bug report with the git commit and file changes that resulted in it being marked as closed. This process is performed for bug reports with status of "*RESOLVED FIXED*", "*CLOSED FIXED*", or "*VERIFIED FIXED*". In this process, project change logs are searched for phrases such as "bug 384108" or "fix for 384108" to link that commit with the target bug report. The date of the commit

and the dates where the bug reports changed statuses are also considered. Any reports that link to multiple git commits or revisions, as well as reports that share a fixing commit with another report, are ignored because it is not clear which fixed file is relevant. Per Dallmeier and Zimmerman, bug reports without fixed files are also ignored because they are considered not functional [4]. Employing this heuristic allows us to identify the ID (hash), author, submission time, log, and files included for the commit responsible for submitting the accepted and verified fix to a bug identified in a bug report.

## 7.6 Experiment Setup and Evaluation Metrics

Our experimental setup includes two sets of comparisons. First, we examine the validity of our included API features and commit message features by evaluating our feature set against the feature set used in [32]. Second, we examine the appropriateness of the different ranking algorithms by evaluating the accuracy and performance of each algorithm on our feature set. For this study, we consider a simple naive aggregation of feature scores, the learning-to-rank approach implemented in the rankSVM package used by Tian et al. [17], an ordinal regression algorithm, and a joint-recommendation approach between ordinal regression and learning-to-rank. To run this experiment, the bug fixing history of the project was loaded into a MySQL database. A Python script was created to calculate the features covered in section 5 and the results were fed into Joachim’s SVM-rank tool [13] and the Microsoft Azure Machine Learning Studio.

To mitigate the risk of overfitting, we create disjoint training and test sets by sorting the bug report data chronologically by when they were reported and divided the dataset into 10 equally sized folds where fold 10 is the most recent bug fixing data. The exception to this rule is the AspectJ dataset. Due to its smaller size, the dataset was split into 3 equally sized folds, where fold 3 is the most recent bug fixing data. For each bug report, we calculate the feature scores and aggregate them through one of the mentioned scoring functions for each pairing of a developer and the bug report. We then rank these files in descending order based on these results and identify the position in which the correct developer (the

developer who submitted the code that resulted in the resolution of the bug report) is ranked. The most recent fold (fold 10, or fold 3 for AspectJ) is used as the test set.

We use Accuracy@K evaluation, as many previous studies have employed this metric [16], [29], [31], [32], [41]. This metric identifies the proportion of top-K recommendations that contain the ground truth (the developer that "fixed" the bug report), where K is the number of rankings we consider. For example, if a list of ten recommended developers contained the correct developer in the fifth position, we would record a correct identification for K values of 5, 6, 7, 8, 9, and 10. We consider K values between 1 - 20.



# Chapter 8

## Experimental Results and Evaluation

In this section, we review the results from our experiment, using them to answer each of our research questions. We conducted several experiments to evaluate the accuracy of our feature set as compared to the feature set used in [32], the accuracy of different methods of feature combination, the importance of each feature, and the accuracy of our approach over different training set sizes. It is worth noting that the AspectJ and Tomcat datasets have less than 20 developers, meaning that their accuracy results will inevitably converge to 100%, as our accuracy@K metric shows the top 20 rankings. Based on this, these datasets may not be wholly suitable for inclusion in this study as discussed in Chapter 9. However, they have been included in order to fully replicate the dataset utilized in [16] and [41].

### 8.1 Feature Set Accuracy Evaluation

**RQ1:** Does a model that considers textual similarity between bug reports and version control commit messages, as well as between bug reports and project API specifications, achieve higher accuracy than a model without those features for the problem of automated bug assignee recommendation?

For the first research question, we measure the accuracy@K on each dataset across four models.

1. Our baseline model - a recreation of [32], using features  $\phi_{1-4}$  and  $\phi_{9-18}$
2. The baseline model with the addition of our API similarity features ( $\phi_{1-18}$ )

3. The baseline model with the addition our commit similarity features ( $\phi_{1-4}$  and  $\phi_{9-22}$ )
4. A model containing all features listed in Table 5.1 ( $\phi_{1-22}$ )

Feature combination was performed using a learning-to-rank approach to match the approach used in [32]. We measure the accuracy of all models using the disjoint test and training sets as discussed in Section 7.6. These results are shown in Figures 8.1 - 8.6. The figures referenced in this section only include the results of the baseline and our complete model for better visual distinction, as the API features had little to no impact on the accuracy of the model (meaning that our first and second models had near identical accuracies and our third and fourth models had near identical accuracies). Figures charting the accuracy of all 4 models can be found in Appendix A.

These Figures show that the accuracy of our model matches or exceeds the accuracy of the baseline model at all k-values across every project. Statistical Hypothesis testing shows that our approach significantly outperforms the approach used in [32] ( $p < 0.05$ ) across all datasets. Our approach is particularly effective on the larger Eclipse Platform UI dataset, outperforming the baseline approach by 6 - 17% across all k-values, with our accuracy being at least 10% higher for all k values of 1 - 10, as shown in figure 8.3. For the AspectJ and JDT datasets, we outperform the baseline model by up to 2.25%. For the BIRT dataset, we outperform the baseline by up to 2.5%. For the SWT dataset, we outperform the baseline by up to 4%. For the Tomcat dataset we outperform the baseline by up to 1%. These consistently higher accuracies show that the use of commit messages to profile developers has significantly improved the accuracy of determining the appropriate developer for a given bug report.

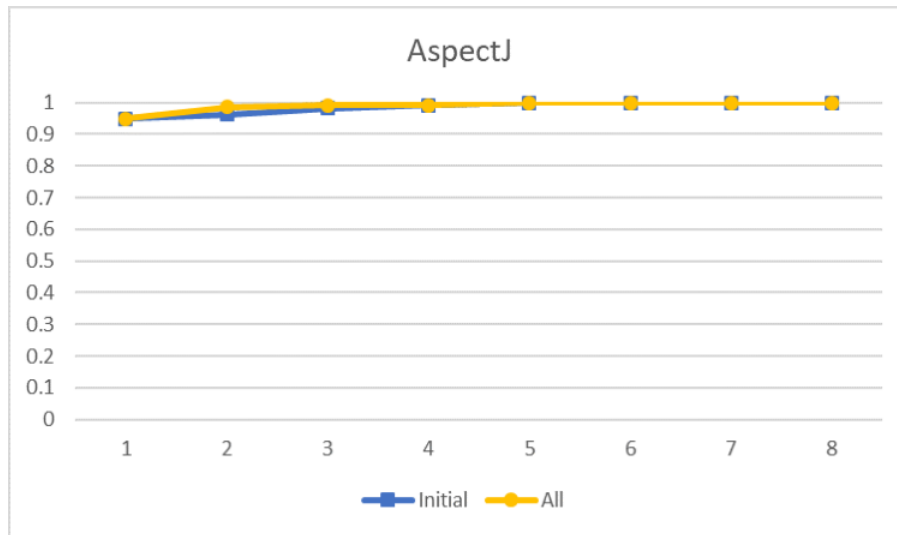

Figure 8.1: Accuracy Comparison Between Features for AspectJ

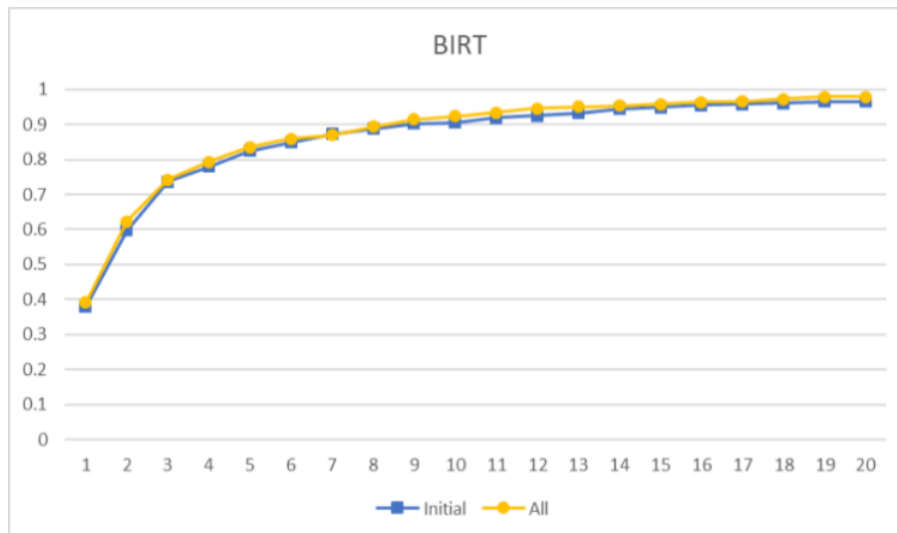

Figure 8.2: Accuracy Comparison Between Features for BIRT

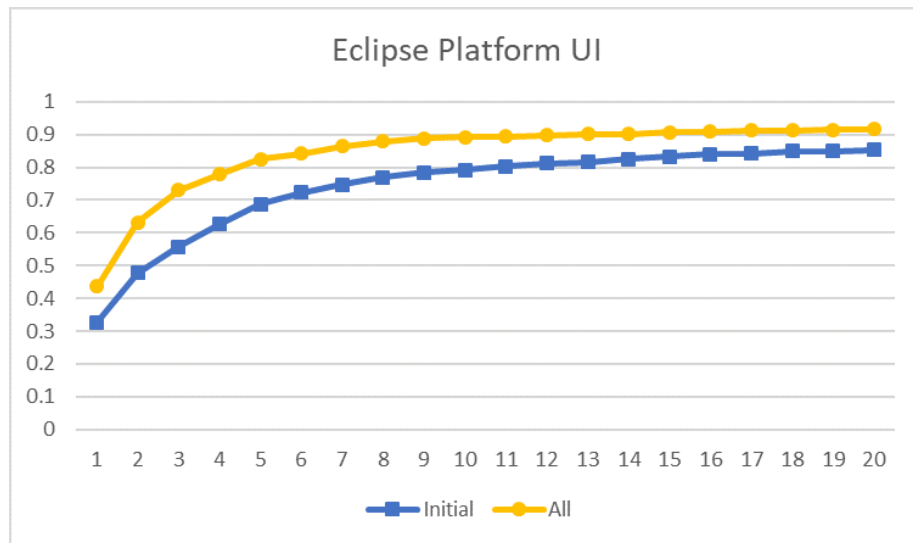

Figure 8.3: Accuracy Comparison Between Features for Eclipse Platform UI

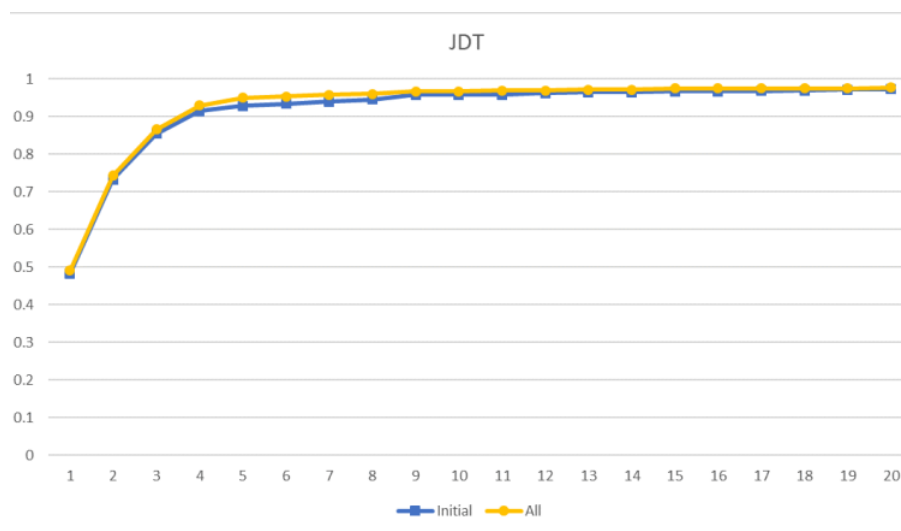

Figure 8.4: Accuracy Comparison Between Features for JDT

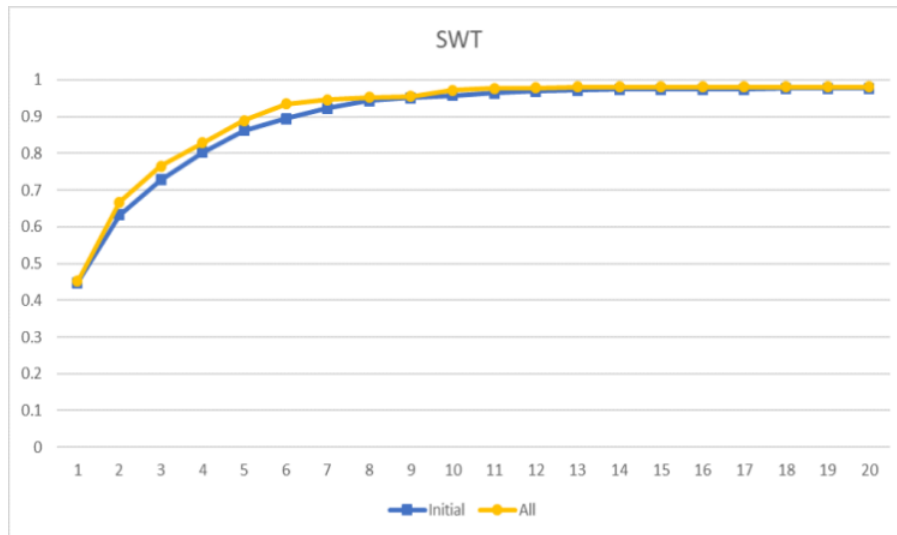

Figure 8.5: Accuracy Comparison Between Features for SWT

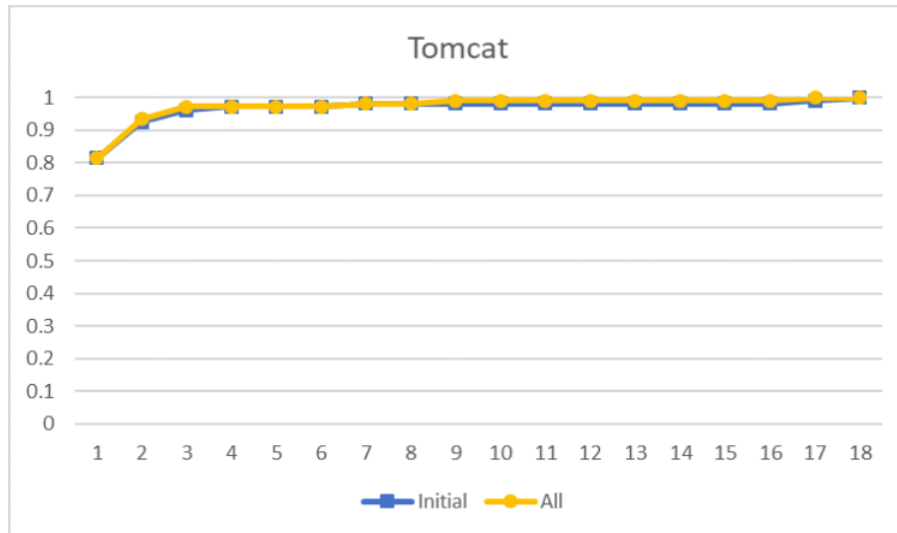

Figure 8.6: Accuracy Comparison Between Features for Tomcat

## 8.2 Feature Combination Accuracy Evaluation

**RQ2:** Which method of feature combination for our features (between naive aggregation, learning-to-rank, and ordinal regression) is most suitable for bug triage?

For our second research question, we measure the accuracy@K of our feature set, which has been shown in Section 8.1 to achieve consistently higher or equal accuracy, across three types of feature combination methods - naive aggregation, learning-to-rank, and ordinal regression. These results are shown in Figures 8.7 - 8.12.

The learning-to-rank approach matches or exceeds the accuracy of the naive approach at all K values for the AspectJ, Eclipse Platform UI, and Tomcat datasets. The learning-to-rank approach matches or exceeds the naive approach for most K values in the BIRT, JDT, and SWT datasets, but is outperformed across several k values. However, for all k-values where the naive approach is more accurate, it outperforms the learning-to-rank approach by only a combined average of 0.5%. The ordinal regression approach yielded significantly worse results, with an accuracy 20-70% lower than the learning-to-rank approach across datasets where there were more than 20 developers. Interestingly, the accuracy does not perceptibly change above K=5 for the ordinal regression approach in datasets with more than 20 developers. This means that in all predictions, if the ordinal regression approach identified the correct developer/bug report pairing, it was in the top five results. This suggests that the ordinal regression approach may be more suited for use as a component of a joint recommendation technique that focuses on improving accuracies at lower K-values. These results show that the learning-to-rank approach used in [32] is typically the best suited method of feature combination for bug triage.

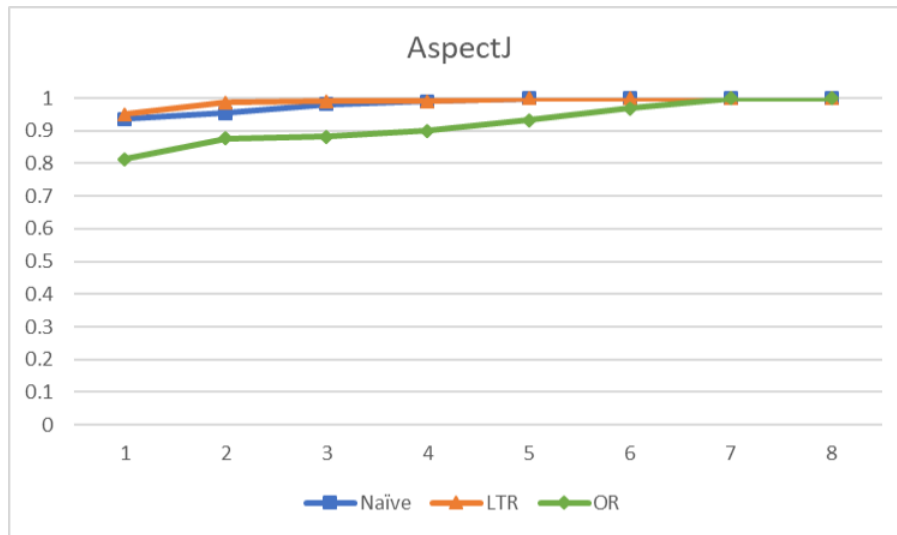

Figure 8.7: Accuracy Comparison Across Feature Combination for AspectJ

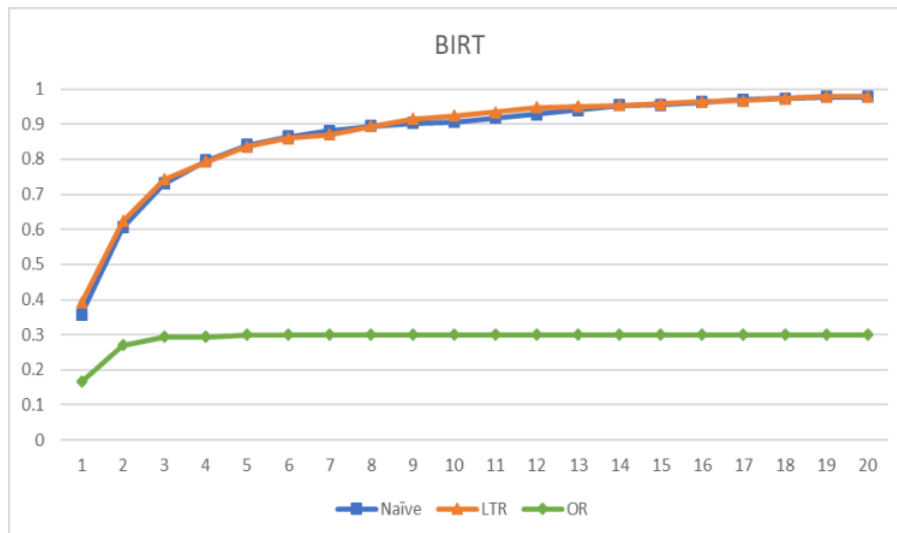

Figure 8.8: Accuracy Comparison Across Feature Combination for BIRT

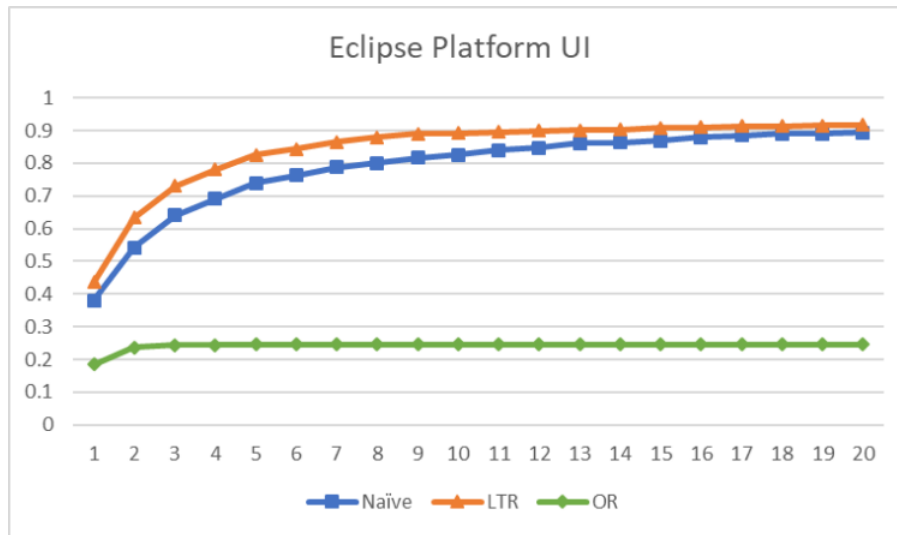

Figure 8.9: Accuracy Comparison Across Feature Combination for Eclipse

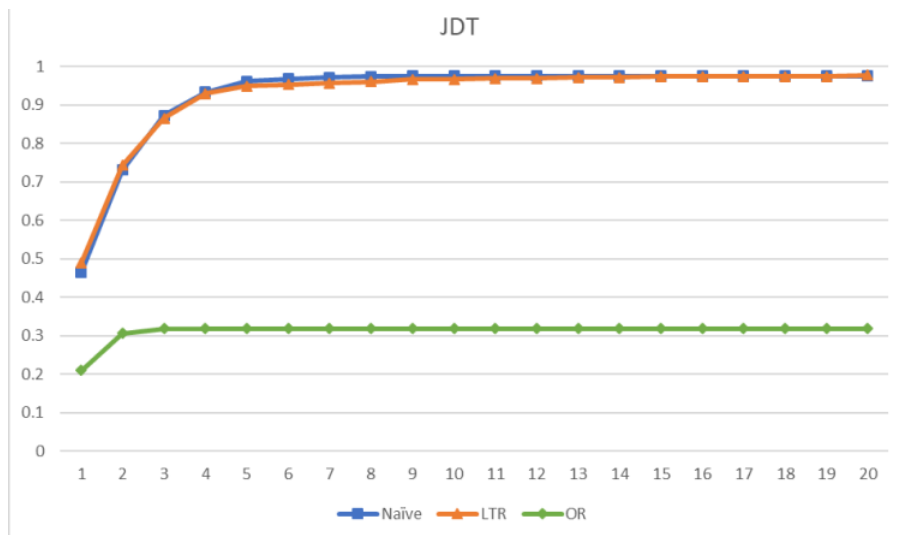

Figure 8.10: Accuracy Comparison Across Feature Combination for JDT





Figure 8.11: Accuracy Comparison Across Feature Combination for SWT

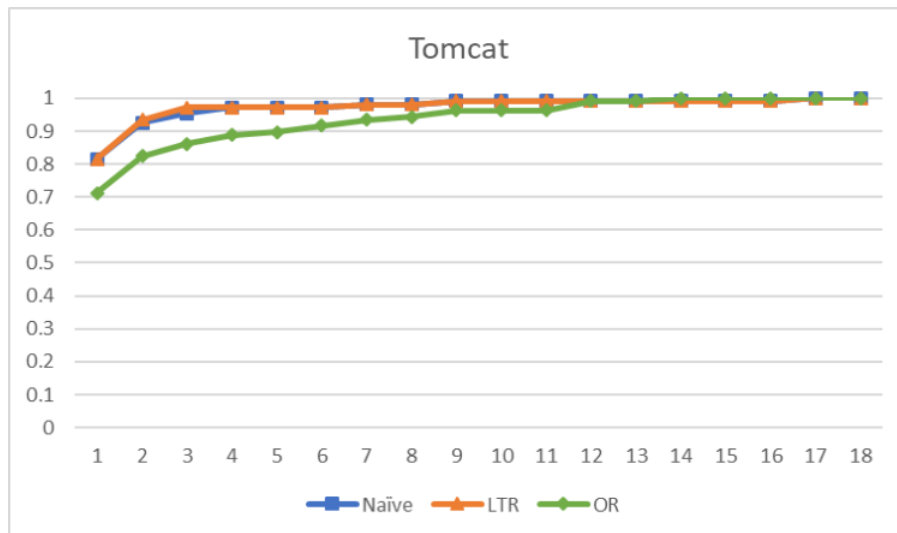

Figure 8.12: Accuracy Comparison Across Feature Combination for Tomcat

### 8.3 Joint-Recommendation Accuracy Evaluation

**RQ3:** Does a joint recommendation approach offer superior accuracy as compared to its component parts?

For our third research question, we measure the accuracy@K of our feature set across the learning-to-rank method of feature combination and the joint-recommendation technique described in Section 6.4. Across every dataset, the accuracy of the joint-recommendation technique was within 0.89% of the learning-to-rank accuracy for all K-values, with the exception of the JDT Dataset, in which the joint-recommendation approach outperformed the learning-to-rank approach at K=1 by 1.25%. Additionally, one approach was not consistently more accurate than the other, with both approaches offering a slightly higher accuracy at various K-values. Finally, statistical hypothesis testing shows that the joint-recommendation approach does not significantly outperform the learning-to-rank approach. Therefore, we can conclude that the joint-recommendation technique does not offer superior accuracy as compared to its component parts for the problem of bug triage.

## 8.4 Evaluation of Feature Importance

**RQ4:** Which features are most important to the accuracy of our model?

To empirically measure the importance of each feature, we can examine the weight assigned to them during the learning-to-rank process. Features that are assigned a higher weight are of more importance to the accuracy of the model, while features with a lower or negative weight are less important to the accuracy of the model. To mitigate the risk of an overfitted model, we will examine the weights across each individual project, as well as their average. The top 5 weighted features for each project are shown in Table 8.1. Novel features implemented by this study are shown in bold. The weights for all 22 features across each project is shown in Table B.1.

Table 8.1 shows that for the average weight and all projects except Tomcat and JDT, two of the features proposed by this study are ranked as the two most important features. For Tomcat and JDT, two of the features proposed by this study are in the top 3 most important features. Specifically,  $\phi_{20}$  (the average cosine similarity between the bug report and each of the developer’s previous commit messages) has the highest weight across four datasets

Table 8.1: Top-5 Weighted Features for each project

Feature Weights							
Rank	AspectJ	BIRT	Eclipse UI	JDT	SWT	Tomcat	Average
1	$\phi_{22}$	$\phi_{20}$	$\phi_{20}$	$\phi_{20}$	$\phi_{20}$	$\phi_{16}$	$\phi_{20}$
2	$\phi_8$	$\phi_6$	$\phi_{22}$	$\phi_{10}$	$\phi_{22}$	$\phi_{22}$	$\phi_{22}$
3	$\phi_4$	$\phi_{10}$	$\phi_{10}$	$\phi_8$	$\phi_{10}$	$\phi_{19}$	$\phi_{10}$
4	$\phi_1$	$\phi_3$	$\phi_7$	$\phi_1$	$\phi_2$	$\phi_9$	$\phi_1$
5	$\phi_{16}$	$\phi_{15}$	$\phi_1$	$\phi_{22}$	$\phi_2$	$\phi_{13}$	$\phi_3$

and the average.  $\phi_{22}$  (the cosine similarity between the bug report and all of the developer’s previous commit messages) is also ranked first or second in four datasets and the average. The presence of these features among the top weighted features across all datasets indicates that our features are both relevant and important to the accuracy of the model. Furthermore, three of the four commit message related features ( $\phi_{19-22}$ ) were assigned a weight greater than 1, indicating that this group of features is an important consideration for assigning bug reports to developers.  $\phi_{20}$  and  $\phi_{22}$  were weighted notably above 1.0, with average weights of 8.9 and 3.68, respectively. This shows that these features are considerably important to the accuracy of the model.

## 8.5 Training Size Impact Evaluation

**RQ5:** Does the size of the training dataset have a significant impact on the accuracy of the classifier for the problem of automated bug assignee recommendation?

To answer our fifth research question, we conducted an experiment to evaluate the impact of training data sizes on the accuracy of our classifier. The data from  $fold_{10}$  was used as a test set. We initially used all 9 remaining folds as a training set. We then reduced the number of folds used in the training set, removing the oldest fold for each trial, until we concluded by just using  $fold_9$  (the most recent training data) as the training set.

Figure 8.13 shows the accuracy corresponding to the different numbers of folds used in training. As seen, accuracy does not substantially change when the number of folds

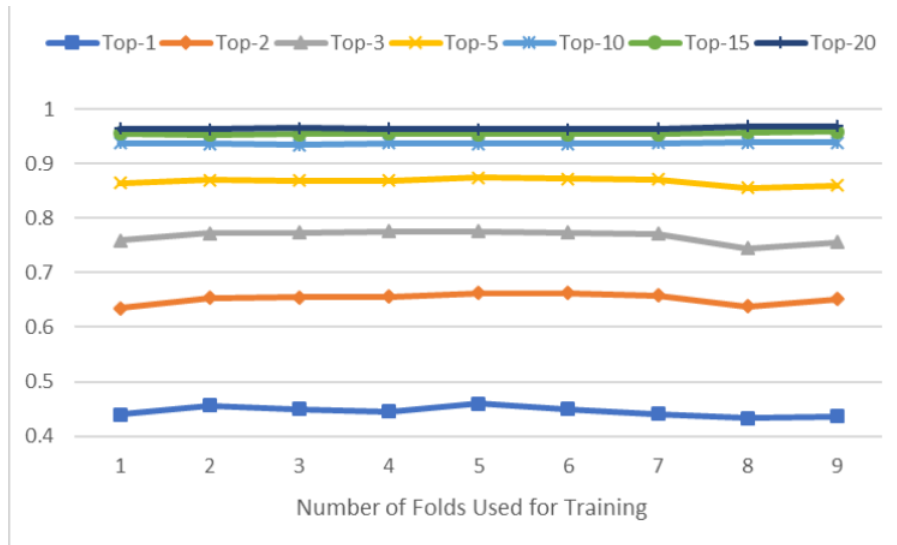

Figure 8.13: Top-K Accuracy with Varied Training Data Sizes

is varied. This is consistent with the findings of Lam et al. [16] for the problem of bug localization. They posit that this is reasonable due to the temporal locality of bug fixing activity, where the files that were recently fixed are more likely to require similar fixing again in the near future. This means that developers assigned to work on these bugs would likely be selected again to work on the new bug. Additionally, this offers the benefit of achieving near-optimal accuracy with a smaller training dataset, reducing the time and memory complexity requirements of training the classifier.

# Chapter 9

## Threats to Validity and Future Work

In this chapter, we identify several threats to the validity of our study and identify future work for this topic. We group our threats into Internal Threats, Construct Threats, and External Threats to validity. We then review a list of potential areas of future work that could prove valuable to this study going forward.

### 9.1 Threats to Validity

Internal Threats to validity include potential errors in the implementation of our approach, using a different language from previous studies (Python was used in our study to obtain the feature scores, where the previous approach in [32] used Java), and distributing our data processing across several virtual machines. To mitigate these risks, we reviewed our code to identify any errors. Additionally, we ensured that the virtual machines had identical configurations by creating and configuring the first virtual machine and only creating additional VMs by cloning the first machine. Finally, we feel that the approach itself is language-agnostic and the language used to create the approach will not impact the mathematical calculations of the features.

Construct Threats to validity include the suitability of our evaluation metrics, the appropriateness of the ordinal regression algorithm, the appropriateness of our joint recommendation technique, the appropriateness of our dataset, and our assumption of the correctness of previous work in [16] and [32]. We use accuracy@K metrics, which have been commonly used in previous studies on this problem and other related problems, including [16],

[29], [31], [32], and [41]. We feel this widespread adoption justifies the use of accuracy@K as our evaluation metric. With regards to the appropriateness of ordinal regression, previous studies have shown that ordinal regression is appropriate for ranking problems [7]. Given that this process of bug triage is a ranking problem, ordinal regression is therefore appropriate. It is possible that our joint recommendation technique is not sufficiently robust to suitably aggregate results from the learning-to-rank and ordinal regression approaches. Implementation of a more robust joint recommendation technique has been defined as out of scope and is left for a future work of this study. The AspectJ and Tomcat datasets may not be suitable for inclusion in this study, as they both have less than 20 developers who participated in bug-fixing development activity for the project. However, we include multiple other projects that featured 37 - 122 developers who participated in bug fixing activity. Finally, we draw heavily from the features and methodology of Tian et al. and rely on the dataset and findings of Lam et al. [16], [32]. We feel that the approach, evaluation, and consideration of threats to validity of Tian's approach are sound, comprehensively documented, and we accept their findings as valid. The dataset used by Lam et al. has seen documented use in several previous studies [16], [41].

External Threats to validity relate to the generalizability of our findings for this evaluation. We evaluate our findings on the projects listed in table 7.2. The selected subject projects may not be sufficiently representative of all projects, meaning that our approach is not sufficiently generalizable. However, these projects have been used in previous studies as noted above and were selected to represent java projects of varying project duration, team size, and count of bug reports [16], [41].

## 9.2 Future Work

There are two main areas of improvements to explore for future work - increasing the usefulness of our textual data in feature extraction and exploring the suitability of different algorithms and approaches to aggregating feature scores. To increase the usefulness of our textual data, there are several alterations we can make. First, there may be words that, while

not present in the standard list of stop words, are used so frequently in bug reports that they lose any value in text similarity comparisons (e.g. "bug" or "fix"). To resolve this issue, we plan to identify the 30 most common words used across the bug report data and include them in the list of stop words removed before cosine similarity calculations.

Another manner in which we can improve our cosine similarity calculations is by narrowing the focus of the touched code for a developer. Previous studies have considered the entire touched file regardless of what specific contributions the developer made to the file. Narrowing the focus of these features to the method level or to only include the developer's specific contributions could offer a more accurate calculation of relevancy between a developer and a bug report. Furthermore, the use of a different textual similarity calculation method, such as Word2vec, could be explored. Word2vec is a group of two-layer neural networks that reconstruct the linguistic context of a word as a vector and provides state-of-the-art word embeddings [6].

The low accuracy from using just ordinal regression is consistent with the low accuracy of the Deep Neural Network-based approach used in [16]. The similarities between these results motivate the exploration of a joint recommendation technique similar to the one used by Lam et al., which was shown to offer a higher accuracy than any of its component parts. Similarly, we plan to implement their DNN-based Localization technique, *DNNLOC*. This approach offered a higher accuracy than the learning-to-rank approach used in [41], especially at low k-values. Tian et al. identify Ye's localization approach being insufficiently accurate as a weakness of their approach. While we used that approach in this study to ensure an accurate replication, we plan to explore an implementation of DNN-based bug localization.

Recent studies have shown that not all previously closed bug reports are relevant for a given open report, especially if they contain stack traces that are treated as just natural text. As a result, these closed reports can represent extraneous noise in the search space and incur a significant computational overhead for the localization and assignment [26]. We have identified multiple bug reports containing method invocations and stack traces

in the data used for this study, but define query optimization [25] as out of this study's scope. This does not affect the comparison of this study's algorithms, as this exclusion is consistent between all algorithms. However, we plan to conduct a future comparative study to evaluate the impact of query optimization on the performance of each algorithm. Finally, our model exceeds the accuracy of the previous model used in [32] by the greatest margin on the Eclipse Platform UI dataset, which has significantly more developers than the other datasets. A comparative study using other projects with a similar number of developers could offer insight into if our model is particularly well-suited to projects with large numbers of developers.

Finally, developer assignment is not always a clear cut case of assigning the bug report to the best suited developer in every instance. The best suited developer to fix a bug report may be out of office, busy with other work, or otherwise unavailable. In the event of a high-priority bug, waiting until that developer is free may not be a viable solution, so the project manager may consider assigning the bug to the next most suited developer that is currently available. To address this scenario, we plan to explore, quantify, and implement an expanded set of developer-profile based features that address issues such as availability, scheduling conflicts, current workload, and overall developer expertise.



# Chapter 10

## Conclusion

This paper presents a new set of features for inclusion in a ranking model for assigning bug reports to the developer most suited to work on them based on historical bug fixing data. We conduct a comparative study against the previous model defined in [32] to empirically validate the appropriateness of our new features. Furthermore, we examine the weights assigned to our features in the learning-to-rank model as compared to other features in the model to verify that our proposed features are relevant to the performance of the model. Results indicate that our model offers higher accuracy than the previous approach and that our features are relevant to the accuracy of the model. Additionally, we conduct an evaluation of four different feature combination approaches - naive aggregation, learning-to-rank, ordinal regression, and a joint-recommendation approach. Our evaluation shows that the learning-to-rank approach generally offers higher accuracy than the other approaches. Finally, we conduct an experiment to evaluate the impact of training data sizes on our classifier's accuracy. Our evaluation shows that training on the most recent fold of bug fixing data is comparably accurate to training on the entire bug fixing history of the project.

# Bibliography

- [1] John Anvik and Gail C. Murphy. Reducing the effort of bug report triage: Recommenders for development-oriented decisions. *ACM Trans. Softw. Eng. Methodol.*, 20(3):10:1–10:35, August 2011.
- [2] Adrian Bachmann, Christian Bird, Foyzur Rahman, Premkumar Devanbu, and Abraham Bernstein. The missing links: Bugs and bug-fix commits. In *Proceedings of the Eighteenth ACM SIGSOFT International Symposium on Foundations of Software Engineering*, FSE '10, pages 97–106, New York, NY, USA, 2010. ACM.
- [3] Bernd Bruegge and Allen H. Dutoit. *Object-Oriented Software Engineering Using UML, Patterns, and Java*. Prentice Hall Press, Upper Saddle River, NJ, USA, 3rd edition, 2009.
- [4] Valentin Dallmeier and Thomas Zimmermann. Extraction of bug localization benchmarks from history. In *Proceedings of the Twenty-second IEEE/ACM International Conference on Automated Software Engineering*, ASE '07, pages 433–436, New York, NY, USA, 2007. ACM.
- [5] Mark Dowson. The ariane 5 software failure. *SIGSOFT Softw. Eng. Notes*, 22(2):84–, March 1997.
- [6] Yoav Goldberg and Omer Levy. word2vec explained: deriving mikolov et al.'s negative-sampling word-embedding method. *CoRR*, abs/1402.3722, 2014.
- [7] B. Gu, V. S. Sheng, K. Y. Tay, W. Romano, and S. Li. Incremental support vector learning for ordinal regression. *IEEE Transactions on Neural Networks and Learning Systems*, 26(7):1403–1416, July 2015.

- [8] Monika Gupta and Ashish Sureka. Nirikshan: Mining bug report history for discovering process maps, inefficiencies and inconsistencies. In *Proceedings of the 7th India Software Engineering Conference, ISEC '14*, pages 1:1–1:10, New York, NY, USA, 2014. ACM.
- [9] S. Hangal and M. S. Lam. Tracking down software bugs using automatic anomaly detection. In *Proceedings of the 24th International Conference on Software Engineering. ICSE 2002*, pages 291–301, May 2002.
- [10] Emily Hill, Lori Pollock, and K. Vijay-Shanker. Exploring the neighborhood with dora to expedite software maintenance. In *Proceedings of the Twenty-second IEEE/ACM International Conference on Automated Software Engineering, ASE '07*, pages 14–23, New York, NY, USA, 2007. ACM.
- [11] Md Kamal Hossen, Huzefa Kagdi, and Denys Poshyvanyk. Amalgamating source code authors, maintainers, and change proneness to triage change requests. In *Proceedings of the 22nd International Conference on Program Comprehension*, pages 130–141. ACM, 2014.
- [12] Gaeul Jeong, Sunghun Kim, and Thomas Zimmermann. Improving bug triage with bug tossing graphs. In *Proceedings of the the 7th joint meeting of the European software engineering conference and the ACM SIGSOFT symposium on The foundations of software engineering*, pages 111–120. ACM, 2009.
- [13] Thorsten Joachims. Training linear svms in linear time. In *Proceedings of the 12th ACM SIGKDD International Conference on Knowledge Discovery and Data Mining, KDD '06*, pages 217–226, New York, NY, USA, 2006. ACM.
- [14] K.S. Jones and P. Willett. *Readings in information retrieval*. Morgan Kaufmann, 1997.
- [15] D. Kim, Y. Tao, S. Kim, and A. Zeller. Where should we fix this bug? a two-phase

- recommendation model. *IEEE Transactions on Software Engineering*, 39(11):1597–1610, Nov 2013.
- [16] A. N. Lam, A. T. Nguyen, H. A. Nguyen, and T. N. Nguyen. Bug localization with combination of deep learning and information retrieval. In *2017 IEEE/ACM 25th International Conference on Program Comprehension (ICPC)*, pages 218–229, May 2017.
- [17] Ching-Pei Lee and Chih-Jen Lin. Large-scale linear ranksvm. *Neural Comput.*, 26(4):781–817, April 2014.
- [18] N. G. Leveson and C. S. Turner. An investigation of the therac-25 accidents. *Computer*, 26(7):18–41, July 1993.
- [19] Ling Li and Hsuan-Tien Lin. Ordinal regression by extended binary classification. In *Proceedings of the 19th International Conference on Neural Information Processing Systems, NIPS’06*, pages 865–872, Cambridge, MA, USA, 2006. MIT Press.
- [20] Mario Linares-Vásquez, Kamal Hossen, Hoang Dang, Huzefa Kagdi, Malcom Gethers, and Denys Poshyvanyk. Triaging incoming change requests: Bug or commit history, or code authorship? In *2012 28th IEEE International Conference on Software Maintenance (ICSM)*, pages 451–460. IEEE, 2012.
- [21] Stacy K. Lukins, Nicholas A. Kraft, and Letha H. Etzkorn. Bug localization using latent dirichlet allocation. *Information and Software Technology*, 52(9):972 – 990, 2010.
- [22] Christopher D. Manning, Prabhakar Raghavan, and Hinrich Schütze. *Introduction to Information Retrieval*. Cambridge University Press, New York, NY, USA, 2008.
- [23] A. T. Nguyen, T. T. Nguyen, J. Al-Kofahi, H. V. Nguyen, and T. N. Nguyen. A topic-based approach for narrowing the search space of buggy files from a bug report. In

- 2011 26th IEEE/ACM International Conference on Automated Software Engineering (ASE 2011)*, pages 263–272, Nov 2011.
- [24] Anh Tuan Nguyen, Tung Thanh Nguyen, Jafar Al-Kofahi, Hung Viet Nguyen, and Tien N Nguyen. A topic-based approach for narrowing the search space of buggy files from a bug report. In *Proceedings of the 2011 26th IEEE/ACM International Conference on Automated Software Engineering*, pages 263–272. IEEE Computer Society, 2011.
- [25] Mohammad Masudur Rahman and Chanchai K Roy. Improving bug localization with report quality dynamics and query reformulation. In *Proceedings of the 40th International Conference on Software Engineering: Companion Proceedings*, pages 348–349. ACM, 2018.
- [26] Mohammad Masudur Rahman and Chanchal K Roy. Improving ir-based bug localization with context-aware query reformulation. In *Proceedings of the 2018 26th ACM Joint Meeting on European Software Engineering Conference and Symposium on the Foundations of Software Engineering*, pages 621–632. ACM, 2018.
- [27] Ripon K Saha, Matthew Lease, Sarfraz Khurshid, and Dewayne E Perry. Improving bug localization using structured information retrieval. In *Automated Software Engineering (ASE), 2013 IEEE/ACM 28th International Conference on*, pages 345–355. IEEE, 2013.
- [28] Ramin Shokripour, John Anvik, Zarinah M Kasirun, and Sima Zamani. Why so complicated? simple term filtering and weighting for location-based bug report assignment recommendation. In *Mining Software Repositories (MSR), 2013 10th IEEE Working Conference on*, pages 2–11. IEEE, 2013.
- [29] Ramin Shokripour, John Anvik, Zarinah M. Kasirun, and Sima Zamani. Why so

- complicated? simple term filtering and weighting for location-based bug report assignment recommendation. In *Proceedings of the 10th Working Conference on Mining Software Repositories*, MSR '13, pages 2–11, Piscataway, NJ, USA, 2013. IEEE Press.
- [30] Vinayak Sinha, Alina Lazar, and Bonita Sharif. Analyzing developer sentiment in commit logs. In *Proceedings of the 13th International Conference on Mining Software Repositories*, MSR '16, pages 520–523, New York, NY, USA, 2016. ACM.
- [31] Ahmed Tamrawi, Tung Thanh Nguyen, Jafar M. Al-Kofahi, and Tien N. Nguyen. Fuzzy set and cache-based approach for bug triaging. In *Proceedings of the 19th ACM SIGSOFT Symposium and the 13th European Conference on Foundations of Software Engineering*, ESEC/FSE '11, pages 365–375, New York, NY, USA, 2011. ACM.
- [32] Y. Tian, D. Wijedasa, D. Lo, and C. Le Goues. Learning to rank for bug report assignee recommendation. In *2016 IEEE 24th International Conference on Program Comprehension (ICPC)*, pages 1–10, May 2016.
- [33] Michele Tufano, Cody Watson, Gabriele Bavota, Massimiliano Di Penta, Martin White, and Denys Poshyvanyk. An empirical investigation into learning bug-fixing patches in the wild via neural machine translation. In *Proceedings of the 33rd ACM/IEEE International Conference on Automated Software Engineering*, ASE 2018, pages 832–837, New York, NY, USA, 2018. ACM.
- [34] Qianqian Wang, Chris Parnin, and Alessandro Orso. Evaluating the usefulness of ir-based fault localization techniques. In *Proceedings of the 2015 International Symposium on Software Testing and Analysis*, pages 1–11. ACM, 2015.
- [35] Shaowei Wang and David Lo. Version history, similar report, and structure: Putting

- them together for improved bug localization. In *Proceedings of the 22Nd International Conference on Program Comprehension*, ICPC 2014, pages 53–63, New York, NY, USA, 2014. ACM.
- [36] Shaowei Wang and David Lo. Amalgam+: Composing rich information sources for accurate bug localization. *Journal of Software: Evolution and Process*, 28(10):921–942, 2016.
- [37] Ming Wen, Rongxin Wu, and Shing-Chi Cheung. Locus: Locating bugs from software changes. In *Proceedings of the 31st IEEE/ACM International Conference on Automated Software Engineering*, ASE 2016, pages 262–273, New York, NY, USA, 2016. ACM.
- [38] Rongxin Wu, Hongyu Zhang, Sunghun Kim, and Shing-Chi Cheung. Relink: Recovering links between bugs and changes. In *Proceedings of the 19th ACM SIGSOFT Symposium and the 13th European Conference on Foundations of Software Engineering*, ESEC/FSE ’11, pages 15–25, New York, NY, USA, 2011. ACM.
- [39] Jifeng Xuan, He Jiang, Zhilei Ren, Jun Yan, and Zhongxuan Luo. Automatic bug triage using semi-supervised text classification. *CoRR*, abs/1704.04769, 2017.
- [40] X. Ye, R. Bunescu, and C. Liu. Mapping bug reports to relevant files: A ranking model, a fine-grained benchmark, and feature evaluation. *IEEE Transactions on Software Engineering*, 42(4):379–402, April 2016.
- [41] Xin Ye, Razvan Bunescu, and Chang Liu. Learning to rank relevant files for bug reports using domain knowledge. In *Proceedings of the 22nd ACM SIGSOFT International Symposium on Foundations of Software Engineering*, FSE 2014, pages 689–699, New York, NY, USA, 2014. ACM.
- [42] J. Zhou, H. Zhang, and D. Lo. Where should the bugs be fixed? more accurate information retrieval-based bug localization based on bug reports. In *2012 34th International Conference on Software Engineering (ICSE)*, pages 14–24, June 2012.

- [43] Jian Zhou, Hongyu Zhang, and David Lo. Where should the bugs be fixed? more accurate information retrieval-based bug localization based on bug reports. In *Software Engineering (ICSE), 2012 34th International Conference on*, pages 14–24. IEEE, 2012.



# Appendix A

## RQ1 Full Comparisons

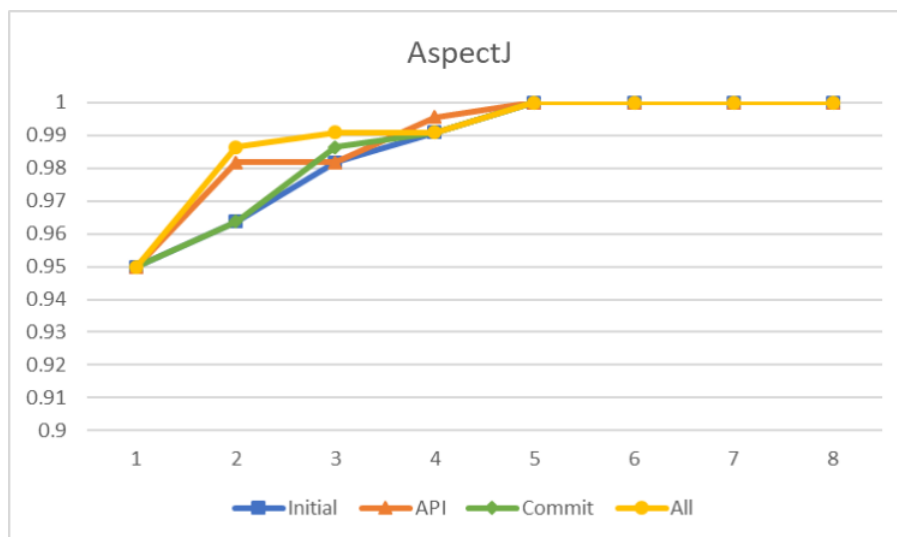

Figure A.1: Accuracy Comparison Between All Features for AspectJ

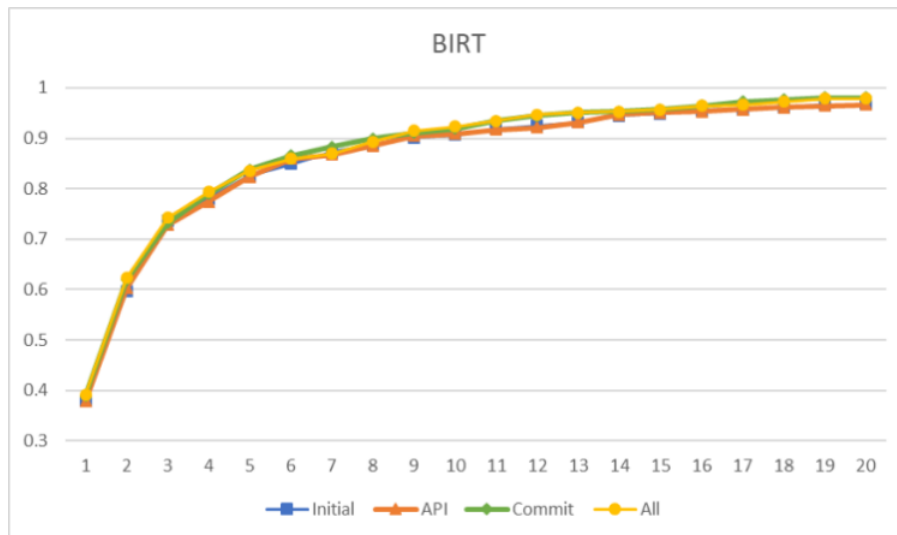

Figure A.2: Accuracy Comparison Between All Features for BIRT

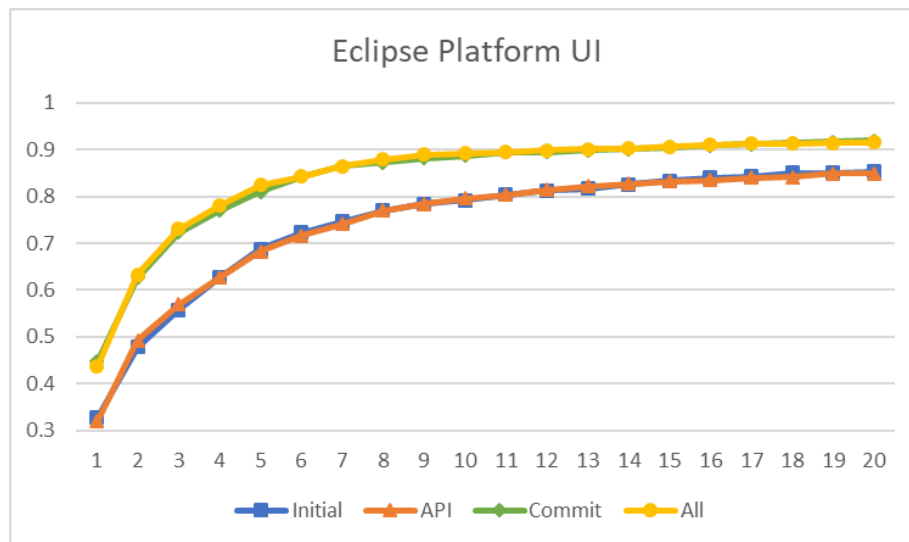

Figure A.3: Accuracy Comparison Between All Features for Eclipse Platform UI

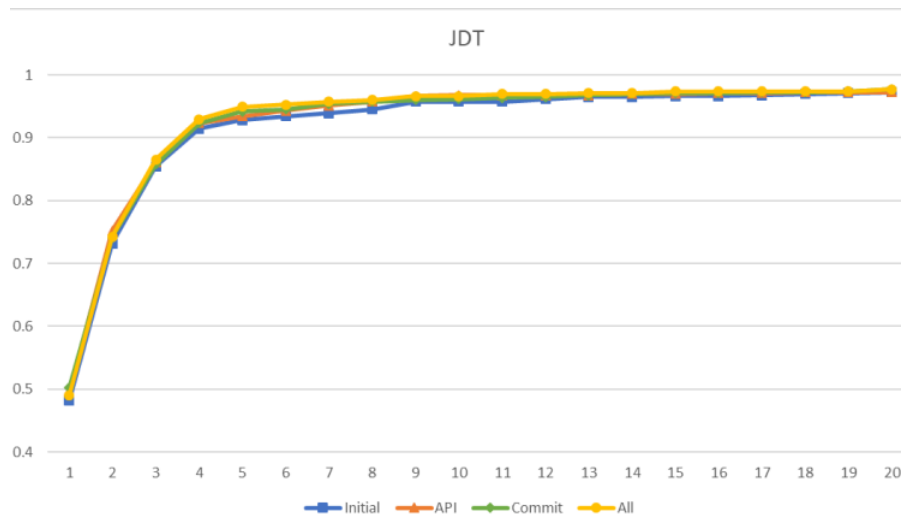

Figure A.4: Accuracy Comparison Between All Features for JDT



Figure A.5: Accuracy Comparison Between All Features for SWT

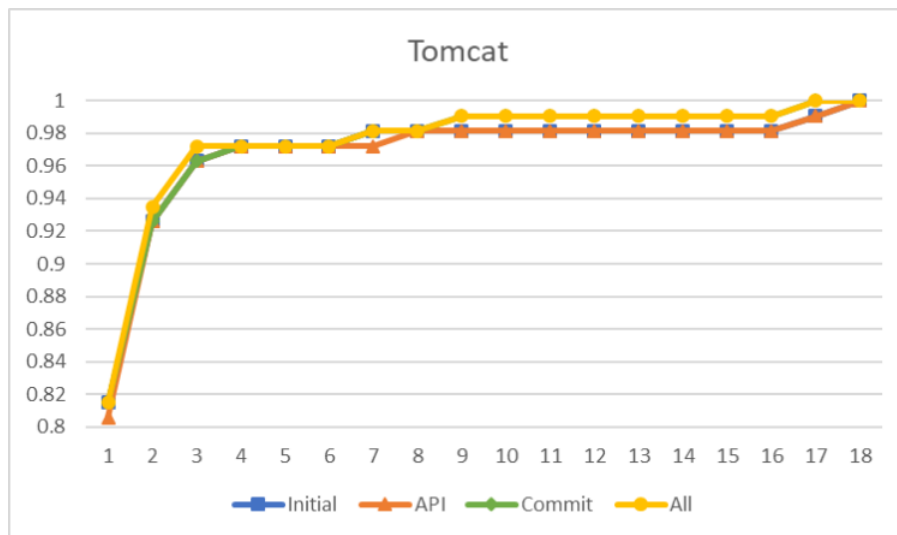

Figure A.6: Accuracy Comparison Between All Features for Tomcat

## Appendix B

### RQ4: All Feature Weights

Table B.1: Weights of all features used in the Ranking Model

Feature Weights							
Feature #	AspectJ	BIRT	Eclipse UI	JDT	SWT	Tomcat	Average
$\phi_1$	1.83	0.32	2.47	4.85	1.91	1.47	2.14
$\phi_2$	0.51	-4.59	0.39	-2.41	3.97	0.43	-0.28
$\phi_3$	1.03	2.75	0.88	2.78	2.79	0.86	1.85
$\phi_4$	2.17	-0.31	1.94	-1.14	-2.36	0.37	0.11
$\phi_5$	1.52	-0.63	1.47	2.01	1.99	0.83	1.2
$\phi_6$	-2.15	3.52	1.71	-3.03	1.57	-0.37	0.21
$\phi_7$	-2.21	0.09	2.66	-1.05	1.43	0.78	0.28
$\phi_8$	2.42	0.05	1.57	5.52	-0.38	0.45	1.6
$\phi_9$	0.76	1.31	0.84	3.33	2.08	2.27	1.76
$\phi_{10}$	0.58	2.95	2.75	7.53	6.37	1.68	3.64
$\phi_{11}$	1.58	2.2	1.25	0.56	1.98	0.26	1.3
$\phi_{12}$	0.12	-0.74	-1.42	-2.09	-0.85	-1.64	-1.1
$\phi_{13}$	1.16	0.88	2.25	1.27	2.46	1.95	1.66
$\phi_{14}$	0.8	0.69	0.7	0.91	0.78	0.65	0.75
$\phi_{15}$	0.73	2.53	-0.12	1.52	0.31	-0.77	0.7
$\phi_{16}$	1.73	0.85	1.06	-1.05	0.98	3.26	1.14
$\phi_{17}$	0.18	0.87	0.17	0.54	0.36	0.04	0.36
$\phi_{18}$	0.61	-0.2	0.73	0.84	-0.15	-0.54	0.21
$\phi_{19}$	0.31	1.2	2.14	1.94	1.76	2.54	1.65
$\phi_{20}$	1.28	14.62	14.82	12.33	9.04	1.33	8.9
$\phi_{21}$	1.28	-0.38	0.98	-1.56	-3.79	0.32	-0.52
$\phi_{22}$	2.46	0.68	3.52	4.27	8.49	2.69	3.68